

HOUSE OF JEWELLERY



EST. 1986

2022
CATALOGUE

ORDER ONLINE HOUSEOFJEWELLERY.COM

HOUSE OF JEWELLERY'S COMPANY POLICIES*

RETURNS

WE GUARANTEE THE QUALITY OF ALL OUR JEWELLERY AND AIM TO SATISFY YOU WITH EVERY PURCHASE. IF ANY ITEM IN YOUR ORDER DOES NOT MEET YOUR EXPECTATIONS, RETURN THE ITEMS TO US AND WE WILL REPLACE IT OR REFUND YOUR PURCHASE. PLEASE ENSURE YOU NOTIFY US WITHIN 7 DAYS OF RECEIVING YOUR PACKAGE.

PRICING

ALL PRICES IN OUR CATALOGUE ARE YOUR WHOLESALE COSTS BASED ON THE CURRENT SILVER OR GOLD MARKET AT THE TIME OF PRINTING. THESE PRICES WILL AUTOMATICALLY BE ADJUSTED WHEN THE MARKET PRICE CHANGES. PLEASE E-MAIL INFO@HOUSEOFJEWELLERY.COM OR CALL US AT 1 (800) 668 - 4422 FOR THE MOST ACCURATE PRICING.

SHIPPING

HOJ OFFERS SHIPPING THROUGH CANADA POST, FEDEX, UPS, PUROLATOR, AND CANPAR. DROPSHIPING MAY BE AVAILABLE FOR YOUR ORDER DEPENDING ON THE PRODUCTS BEING PURCHASED.

PAYMENT TERMS

COD PAYMENTS ARE PREFERRED, BUT PAYMENT TERMS CAN BE ESTABLISHED BY FILLING IN OUR CREDIT APPLICATION ON PAGE 119.

MINIMUM ORDER QUANTITIES (MOQS):

WHEN IT COMES TO REGULAR ORDERS, HOJ REQUIRES A CAD \$150.00 ORDER BEFORE TAXES AND SHIPPING. EXCEPTIONS CAN BE MADE ON A CASE-BY-CASE BASIS. PLEASE CALL OR EMAIL US FOR DETAILS.

*ADDITIONAL CONDITIONS APPLY.
SEE OUR WEBSITE FOR FULL DETAILS.

NEW WEBSITE FEATURES

THE NEW HOUSE OF JEWELLERY (HOJ) SITE HAS IMPROVED GREATLY UPON THE PREVIOUS ONE, MAKING IT AN INDUSTRY-LEADING WEBSITE. THERE HAVE BEEN ONGOING CHANGES TO ITS FUNCTIONALITY, MAKING THE SHOPPING EXPERIENCE FOR YOU - **OUR VALUED CUSTOMER** - EASIER, FASTER, AND MORE CONVENIENT.

SOME OF THE MAIN HIGHLIGHTS INCLUDE:

- ✦ REAL-TIME INVENTORY
- ✦ FIND MY RETAILER SEARCH FUNCTION
- ✦ MOBILE SHOPPING
- ✦ ACCESS TO INVOICES AND CREDIT MEMOS
- ✦ THE HD IMAGE BANK
- ✦ PRODUCT CONFIGURATIONS FOR ELIGIBLE PRODUCTS (SIZING AND/OR PLATING OPTIONS)
- ✦ SHIPPING INFORMATION
- ✦ ORDER HISTORY
- ✦ BACKORDER NOTIFICATIONS

COLOUR LEGEND



AT HOJ, WE HAVE A WIDE SELECTION OF ITEMS THAT HAVE VARIOUS PLATING OPTIONS (E.G. RHODIUM, GOLD, AND ROSE GOLD) TO CHOOSE FROM. PLEASE LOOK FOR THIS LEGEND AS SHOWN NEXT TO APPLICABLE PRODUCT TO SEE OUR COLOUR OPTIONS. PLEASE CONTACT US TO CONFIRM IF THE ITEM IS STILL AVAILABLE IN THE CHOSEN PLATING COLOUR WHEN ORDERING.

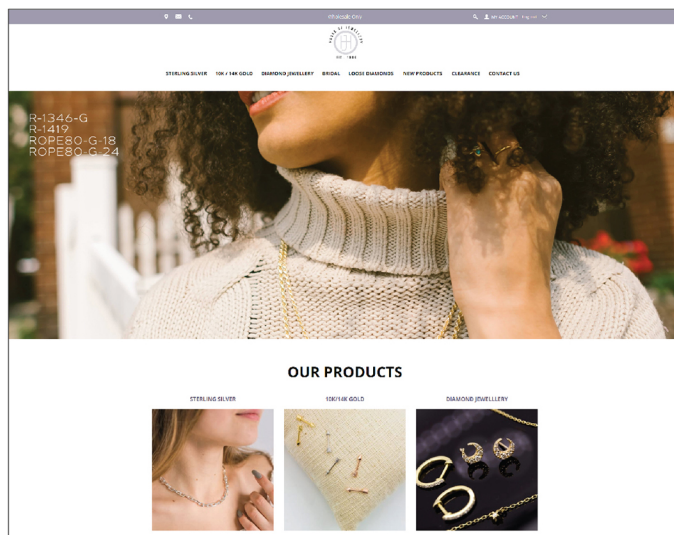

WE STRONGLY ENCOURAGE YOU TO REGISTER ONLINE. THIS WILL GRANT YOU ACCESS TO NEW PRODUCT OFFERINGS AND PRICING INFORMATION. IF YOU NEED ASSISTANCE WITH ONLINE REGISTRATION PLEASE CALL US AT 1 (800) 668-4422.

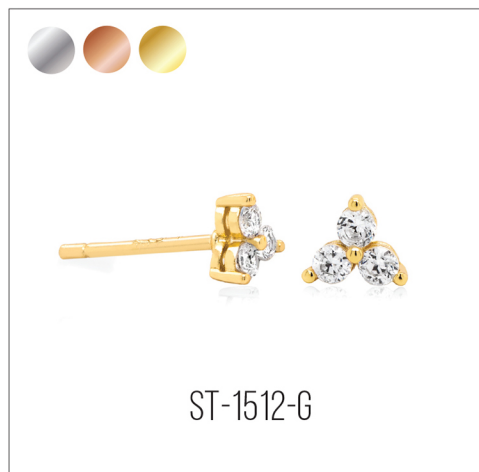

FOLLOW US ON SOCIAL MEDIA



CONNECT WITH US ON SOCIAL MEDIA AND RECEIVE EXCLUSIVE-OFFERS, NEW PRODUCTS, AND OTHER IMPORTANT INFORMATION. WE ENCOURAGE YOU TO SHARE OUR PHOTOS AND CREDIT US (@HOUSEOFJEWELLERY) FOR TAKING THEM.

PRICING INFORMATION

THE SUGGESTED RETAIL PRICE FOR OUR PRODUCTS IS 2 X KEYSTONE FOR SILVER ITEMS AND KEYSTONE FOR GOLD ITEMS. THE PRICE LIST SHOWN AT THE BACK OF THIS CATALOG IS CAD \$ WHOLESALE BASED ON THE CURRENT PRICE (AT THE TIME OF PRINTING) OF SILVER AND FX CURRENCIES. FOR THE MOST ACCURATE PRICING PLEASE VISIT OUR WEBSITE AT WWW.HOUSEOFJEWELLERY.COM OR CALL US AT 1 (800) 668 - 4422.

PRIVATE LABEL

PRIVATE LABELLING IS THE PROCESS OF ENGRAVING OR STAMPING A COMPANY'S LOGO, BRAND NAME, OR OTHER INFORMATION ONTO A PIECE OF JEWELLERY. THIS CAN BE DONE WITH EITHER AN EXISTING HOJ DESIGN OR BY CREATING ONE OF YOUR OWN. PRIVATE LABELLING IS A GREAT WAY TO ADD A CUSTOMIZED ELEMENT TO A PIECE OF JEWELLERY THAT FURTHERS BRAND AWARENESS. IF THIS SOUNDS LIKE SOMETHING OF INTEREST, PLEASE EMAIL US AT [INFO@HOUSEOFJEWELLERY.COM](mailto:info@houseofjewellery.com) TO LEARN MORE OR VISIT US ONLINE.



PERSONALIZED

OUR PERSONALIZED JEWELLERY PRODUCTS ARE A GREAT WAY TO OFFER YOUR CUSTOMERS EMOTIONAL AND SENTIMENTAL ACCESSORIES. THESE PIECES CAN CONTAIN ANY NAME, INITIALS, DATES, AND OTHER INFORMATION THAT RESONATES WITH YOUR CUSTOMERS. PLEASE VISIT OUR WEBSITE FOR OUR ENTIRE PERSONALIZED COLLECTION.

HD IMAGE BANK

IN TODAY'S DIGITAL WORLD, HAVING AN ONLINE PRESENCE IS AN IMPORTANT PART OF THE INDUSTRY. HOWEVER, MAINTAINING THAT ONLINE PRESENCE CAN BE CUMBERSOME. THAT'S WHY WE OFFER OUR CLIENTS ACCESS TO OUR DIGITAL PHOTOS. THESE IMAGES CAN BE USED ON YOUR SOCIAL MEDIA PAGES SO LONG AS THEY FEATURE ITEMS YOU'VE BOUGHT FROM US. WE ASK THAT IN RETURN YOU CREDIT US (@HOUSEOFJEWELLERY) FOR TAKING THE PHOTOS FOR YOUR SOCIAL MEDIA OR MARKETING PURPOSES.

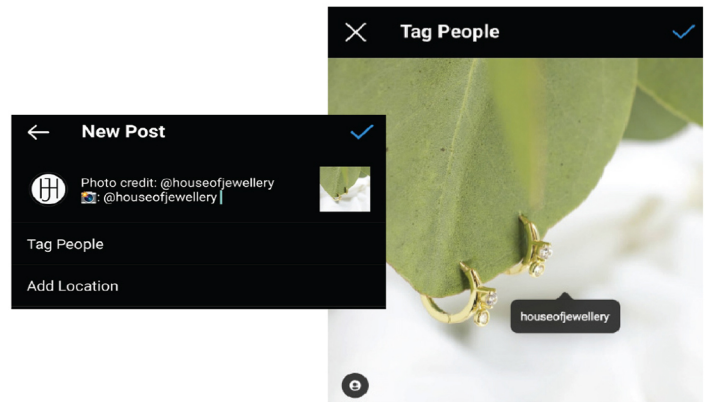

PLATING SERVICES

HOJ IS ABLE TO ASSIST YOU WITH ALL YOUR PLATING NEEDS. OUR IN-HOUSE JEWELLER CAN **RHODIUM**, **GOLD**, OR **ROSE GOLD** PLATE YOUR DESIRED PIECE OF JEWELLERY. PLEASE CONTACT US FOR MORE INFORMATION OR VISIT OUR DEDICATED PLATING PAGE ON OUR WEBSITE.

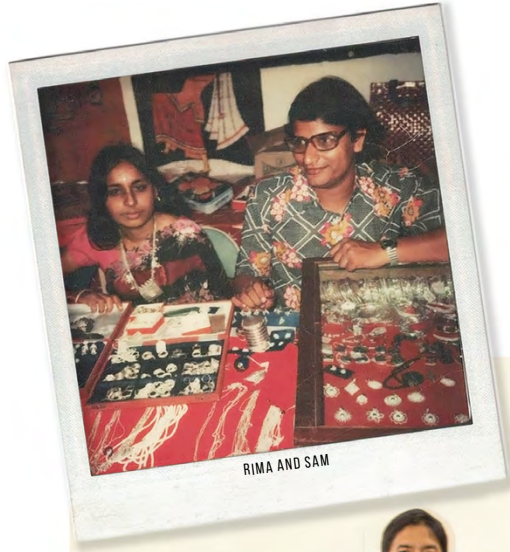

RIMA AND SAM



RISHABH AND RIMA



HOJ FAMILY 2022

About us

SAM AND RIMA CAME TO CANADA FROM INDIA AS NEW IMMIGRANTS IN 1986. NEW TO THE COUNTRY, THEY EMBARKED ON A SIX-MONTH ROAD TRIP FROM COAST TO COAST. ALONG THE WAY, THEY CARRIED EXQUISITE JEWELLERY AND HANDICRAFTS FROM INDIA, MAKING PIT STOPS TO LOCAL RETAILERS TO GENERATE THEIR INITIAL CLIENT BASE. THE RESPONSE WAS OVERWHELMING AND BOTH OF THEM QUICKLY REALIZED THAT THERE WAS A LACK OF WHOLESALE SILVER & GOLD JEWELLERS AVAILABLE TO THE CANADIAN MARKET. SOON AFTER, TORONTO BECAME THEIR NEW HOME. IN 1988, THEY OPENED UP AN OFFICE IN CANADA'S JEWELLERY HUB, 55 QUEEN STREET EAST.

AFTER 30+ YEARS OF EXPERIENCE, THE COMPANY HAS OUTGROWN THAT HOME AND EXPANDED. NOW, AT 27 QUEEN, HOUSE OF JEWELLERY HAS SURPASSED ITS GOAL OF BECOMING ONE OF NORTH AMERICA'S LARGEST JEWELLERY WHOLESALERS.

HOUSE OF JEWELLERY HAS BEEN PASSED DOWN TO RISHABH "RICHARD" KHAMESRA, SAM AND RIMA'S SON.

AS A SECOND-GENERATION FAMILY BUSINESS THAT HAS UNDERGONE MANY CHANGES THROUGH THE YEARS, OUR VALUES REMAIN THE SAME: PRIDE IN BEING TRUSTWORTHY, DEDICATED, AND HARD-WORKING. WE VIEW EACH AND EVERY CUSTOMER AS A FAMILY MEMBER WHO IS TREATED WITH RESPECT AND GIVEN SUPERIOR CUSTOMER SERVICE. WHETHER THROUGH ONLINE, PHONE, FAX, IN-STORE VISITS OR TRADE SHOW PURCHASES, WE SINCERELY WANT TO THANK EACH AND EVERY ONE OF OUR CUSTOMERS FOR THEIR GRACIOUS SUPPORT DURING THE **LAST 30+ YEARS.**

WE OFFER AN EVER-GROWING SELECTION OF PRODUCTS AND SERVICES. SOME OF OUR NEW OFFERINGS INCLUDE - BUT NOT LIMITED - TO PRIVATE LABEL SERVICES, PERSONALIZED NAME JEWELLERY, AND PLATING SERVICES. PLEASE VISIT OUR WEBSITE TO STAY ABREAST OF WHAT WE HAVE TO OFFER OR CONTACT US AT 1 (800) 668 - 4422. WE LOOK FORWARD TO SERVING YOU IN THE VERY NEAR FUTURE.

TABLE OF CONTENTS

2022 CATALOGUE

04

STERLING SILVER CHAINS

STERLING SILVER BASIC CHAINS
STERLING SILVER FANCY CHAINS
OMEGA CHAINS
TWO-TONE OMEGA CHAINS

HERRINGBONE CHAINS
RHODIUM PLATED CHAINS
ADJUSTABLE CHAINS
BLACK RHODIUM
GOLD VERMEIL CHAINS
ROSE GOLD VERMEIL CHAINS

MEDICAL ALERT BRACELETS
ID BRACELETS

16

NECKLACES

TRADITIONAL CZ NECKLACES
TRADITIONAL PLAIN NECKLACES
BAR NECKLACES
EVIL EYE + HAMSA
TRENDY CZ NECKLACES

TRENDY PLAIN NECKLACES
TRENDY PEARL + MOTHER OF PEARL NECKLACES
LARIAT NECKLACES
CHOKERS

26

BRACELETS + BANGLES

STRETCH BRACELETS
MAGNETIC BRACELETS
ROUND ENGRAVED BANGLES
ROUND PLAIN BANGLES
SQUARE ENGRAVED BANGLES
SQUARE PLAIN BANGLES

BABY BANGLES
CZ BANGLES
HAMMERED BANGLES
PLAIN BANGLES
ADJUSTABLE BRACELETS
TRENDY PLAIN BRACELETS

CZ BRACELETS
TENNIS BRACELETS
COLOURFUL CZ BRACELETS
TENNIS NECKLACES
COLOURFUL CZ BRACELETS

36

EARRINGS

HALO STUDS
SANDBLASTED STUDS
FRESHWATER PEARL STUDS
EAR JACKETS
CLASSIC STUDS
ASSORTED EARRINGS

LOVE KNOTS
CZ SCREWBACK STUDS
TRENDY CZ STUDS
TRENDY PLAIN STUDS
LEVERBACK EARRINGS
EAR CLIMBERS

THREADER EARRINGS
ANTI-TARNISH D/C EARRINGS

44

HOOPS + HUGGIES

PLAIN HUGGIES
CZ HUGGIES
BALI HOOPS
TUBE HOOPS
D/C HOOPS
CZ HOOPS

TRENDY HOOPS

52

RINGS

PLAIN RINGS
SIGNET RINGS
TRENDY CZ RINGS
CZ BAND RINGS
ENGAGEMENT SETS
TRADITIONAL CZ

RINGS
COCKTAIL RINGS
EMULATED STONE
CZ COLOURFUL RINGS
DAVID YURMAN

INSPIRED RINGS
BAND RINGS
FLAT BAND RINGS
TIFFANY BAND RINGS
ROLO RINGS

MOVEABLE RING
PUZZLE RINGS
POISON RINGS
CLADDAUGH RINGS

58

PENDANTS + LOCKETS

PLAIN LOCKETS
ENGRAVED LOCKETS
ASSORTED LOCKETS
URN LOCKETS
ITALIAN LOCKETS
CZ PENDANTS

PLAIN PENDANTS
CLASSIC PENDANTS
ROYAL WEDDING SETS
PENDANT SETS
ASSORTED RELIGIONS
PLAIN CROSSES

CZ CROSSES
ASSORTED MEDALLIONS
SAINT CHRISTOPHER
SAINT JOSEPH
SAINT MICHAEL
ROUND + OVAL DOG TAGS

HEART DOG TAGS
TRADITIONAL DOG TAGS
MEDICAL PENDANTS

CHARMS

RELIGIOUS

NAUTICAL
TALKING
SPORTS
ANIMALS
CHARM HOLDERS
ASSORTED

THEMED COLLECTIONS

CANADIAN COLLECTION
CHRISTMAS + SNOWFLAKE
COLLECTION
BIRTHSTONE COLLECTION
OWL COLLECTION
TORONTO COLLECTION
MORGANITE COLLECTION

TREE OF LIFE COLLECTION
FAMILY COLLECTION
NAUTICAL COLLECTION
HELLO KITTY INSPIRED COLLECTION
ALPHABET COLLECTION
SIMULATED OPAL COLLECTION
INFINITY COLLECTION

NATURAL STONE COLLECTION
VAN CLEEF INSPIRED COLLECTION
TIFFANY INSPIRED COLLECTION

MEN'S JEWELLERY

MEN'S RINGS
CUFFLINKS
MEN'S STUDS
TIE BARS
MONEY CLIPS
HIP HOP JEWELLERY

BODY JEWELLERY

TOE RINGS
ANKLETS
NOSE PINGS
SEPTUM RINGS

FINDINGS

ITALIAN SEAMLESS BEADS
JUMP RINGS
SPLIT RINGS
SPRING RINGS
PEAR LOBSTER CLASPS
FIGURE CLASPS

RECTANGULAR LOBSTERS
SCREW CLASPS
"S" CLASP
FISH HOOK CLASP
MAGNETIC CLASPS
BACKINGS

LEATHER CORD
CRIMP
FISH HOOKS/ LEVERBACKS
EXTENDERS
LOOSE ALHAMBRAS
10K + 14K LOBSTERS

10K + 14K BUTTERFLIES
10K + 14K EXTENDERS
10K + 14K JUMP RINGS
10K + 14K SPRING RINGS

10K/14K GOLD JEWELLERY

14K ITALIAN GOLD CHAINS
10K ITALIAN GOLD CHAINS
TRENDY 10K GOLD RINGS
TRENDY 10K GOLD NECKLACES
TRENDY 10K GOLD BRACELETS
TRENDY 10K GOLD EARRINGS

10K GOLD HUGGIES
10K GOLD SLEEPERS
10K GOLD BALL STUDS
10K BASKET SET CZ STUDS
10K GOLD LEVERBACKS
10K GOLD CZ PENDANTS

14K GOLD + DIAMOND STUDS
14K GOLD + DIAMOND HUGGIES
14K GOLD + DIAMOND RINGS
14 GOLD + DIAMOND NECK-
LACES + BRACELETS
14K DIAMOND NOSE RINGS

14K GOLD BALL STUDS
14K GOLD BALL LEVERBACKS
14K GOLD BASKET CZ STUDS
14K GOLD CZ LEVERBACKS

PERSONALIZED

STERLING SILVER EARRINGS
STERLING SILVER NECKLACES
STERLING SILVER RINGS
STERLING SILVER BRACELETS
STERLING SILVER ANKLETS

10K + 14K GOLD NECKLACES
10K + 14K GOLD BRACELETS
10K + 14K SOLID GOLD RINGS

ORDERING INFORMATION

TERMS + CONDITIONS
CREDIT APPLICATION
ORDER FORM
PRICE LIST

68
76
92
96
100
104
113
117



STERLING SILVER CHAINS

STERLING SILVER BASIC CHAINS P. 5 - 7

STERLING SILVER FANCY CHAINS P. 8

OMEGA CHAINS P. 9

TWO-TONE OMEGA CHAINS P. 9

HERRINGBONE CHAINS P. 9

RHODIUM PLATED CHAINS P. 10 - 11

ADJUSTABLE CHAINS P. 11













BLACK RHODIUM P. 11















GOLD VERMEIL CHAINS P. 12 - 13



ROSE GOLD VERMEIL CHAINS P. 13



MEDICAL ALERT BRACELETS P. 14



ID BRACELETS P. 15



FIGARO	
	FIG50
1.8MM 18" 3.4G	
	FIG60
2.2MM 18" 4.56G	
	FIG80
3MM 18" 7.25G	
	FIG100
3.9MM 18" 10.26G	
	FIG120
4.8MM 18" 13.60G	
	FIG150
5.4MM 18" 21.20G	
	FIG180
6.8MM 18" 30.72G	
	FIG220
8.4MM 20" 46.10G	
	FIG250
9.8MM 24" 72.56G	
	FIG300
11MM 24" 98.36G	
	FIG350
13.8MM 24" 151.3G	
	FIG400
15.5MM 24" 171.61G	

CURB		
GD30		1MM 18" 1.50G
GD35		1.2MM 18" 2.0G
*GD50		1.8MM 18" 4G
GD60		2.1MM 18" 5.38G
GD80		2.8MM 18" 8.30G
GD100		3.6MM 18" 12.50G
GD120		4.2MM 18" 16.5G
GD150		5.5MM 18" 26.40G
GD180		6.7MM 18" 36.3G
GD220		8MM 24" 66.70G
GD250		9.5MM 24" 75.60G
GD300		11MM 24" 122.8G
GD350		13.1MM 24" 167.10G
GD400		14.2MM 24" 242.20G

FIGARO PAVE	
	FIGPAVE150
5.5MM 18" 22.70G	
	FIGPAVE180
6.6MM 18" 31.96G	
	FIGPAVE220
8.2MM 24" 61.60 G	













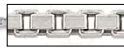

CURB PAVE		
GDPAVE150		5.1MM 18" 23.22G
GDPAVE180		6.7MM 18" 34.55G
GDPAVE220		8.2MM 24" 66.10 G

FIGARO GUCCI	
	FIGG120
4.8MM 18" 13.1G	
	FIGG150
6.6MM 18" 20.41G	
	FIGG180
8.2MM 24" 61.60G	







CURB SQUARE		
GDSQ150		4.4MM 24" 31.60G
GDSQ180		5.5MM 24" 48.90G
GDSQ220		6.6MM 24" 66.60G

MOST CHAINS ARE AVAILABLE IN 7", 8", 9", 16", 18", 20", 22", 24", 26", 28", & 30". ALL WEIGHTS & SIZES ARE APPROXIMATE. QUOTES APPLY TO THE LENGTH SHOWN.
* ALSO AVAILABLE IN 36".







BOX

	0.66MM 18" 1.35G		BOX12
	0.9MM 18" 1.95G		BOX15
	1MM 18" 2.75G		*BOX19
	1.2MM 18" 3.80G		*BOX24
	1.5MM 18" 5.47G		*BOX28
	2.2MM 18" 13G		BOX45
	2.8MM 18" 22.07G		BOX300
	4.3MM 24" 66.30G		BOX500









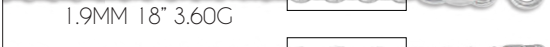
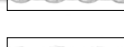

SINGAPORE

	1.5MM 18" 1.60G		SING25
	2.5MM 18" 3.40G		SING40
	3.15MM 18" 5.83G		SING50



ROLO ROUND

	2MM 18" 2.94G		ROLO25
	2.5MM 18" 6.77G		*ROLO45
	3.9MM 18" 14.62G		*ROLO60



ROLO OVAL

	1.6MM 18" 2.60G		ROLO-OV40
	1.9MM 18" 3.60G		*ROLO-OV50
	2.5MM 18" 5.30G		*ROLO-OV60
	3.2MM 18" 9.15G		*ROLO-OV80
	4.8MM 18" 21.30G		ROLO-OV120
	6MM 18" 32.15G		ROLO-OV150





FLAT SNAKE

FSNAKE30		3.4MM 18" 8.96G
FSNAKE40		5.3MM 18" 13.04G
FSNAKE60		6.3MM 18" 29.40G

DIAMOND CUT SNAKE

DC20		0.8MM 18" 2.81G
DC25		0.9MM 18" 3.60G
DC35		1.1MM 18" 5.20G

SNAKE

SNAKE20		0.9MM 18" 3.10G
SNAKE25		1MM 18" 3.95G
SNAKE35		1.4MM 18" 5.92G
SNAKE40		1.5MM 18" 7.18G
SNAKE50		1.8MM 18" 10.70G

SPIGA

SPIGA25		1MM 18" 2.02G
SPIGA35		1.5MM 18" 3.55G
SPIGA50		1.8MM 18" 5.43G
SPIGA60		2.5MM 18" 8.98G

EACH PACK HAS 10 CHAINS.
AVAILABLE IN 16", 18", 20".

1MM		ROLO 10-PACK
1MM		ROLO 10-RH-PACK
1MM		ROLO 10-G-PACK
1MM		ROLO 10-R-PACK

BALL	
1.25MM 18" 2.18G	BALL-1
1.55MM 18" 3.18G	BALL-1.5
2MM 18" 4.43G	BALL-2
3MM 18" 13.16G	BALL-3
4MM 18" 15.95G	BALL-4
5MM 18" 22.10G	BALL-5
6MM 18" 36.68G	BALL-6
7MM 18" 45.28G	BALL-7
8MM 18" 57.08G	BALL-8
9MM 8" 28.15 G	BALL-9
10MM 18" 74.28G	BALL-10
12MM 8" 26.29G	BALL-12



DIAMOND CUT BALL	
1.25MM 18" 2.17G	DCBALL-1
1.55MM 18" 2.90G	DCBALL-1.5
2MM 18" 4.33G	DCBALL-2

ROPE	
1ROPE25	1MM 18" 1.9G
ROPE25	1.6MM 18" 2.2G
ROPE40	2MM 18" 6.14G
ROPE50	2.4MM 18" 8.83G
ROPE60	2.8MM 18" 13.10G
ROPE80	3.8MM 18" 21.67G
ROPE100	4.7MM 20" 37.73G





HOLLOW ROPE	
HROPE-80	4.4MM 20" 13G
HROPE-100	5.3MM 18" 18.8G
HROPE-120	6.5MM 18" 24.7G
HROPE150	8MM 22" 46.3G

FLAT MARINA	
FM25	2.3MM 18" 4G
FM120	4.4MM 18" 15.66G
FM150	5.8MM 24" 31.70 G
FM180	6.9MM 24" 43.40 G

BYZANTINE

	BIZSQ115
7.2MM 18" 40.40G	
	BIZSQ150
8.5MM 24" 67G	
	BIZSQ180
11.2MM 24" 127.95G	

HOLLOW PUFF GUCCI

	PGUCCI-60
6.5MM 7" 7.60G	
	PGUCCI-80
8.6MM 7" 9.1G	
	PGUCCI-100
10.3MM 7" 9.93G	
	PGUCCI-400
12MM 7.5" 20G	







PAPERCLIP







	*PPC80
3.2MM 18" 6.4G	
	PPC120
4.3MM 18" 13.80G	

LOOKING FOR GOLD VERMEIL PAPERCLIP CHAINS? YOU CAN FIND IT ON PAGE 12.

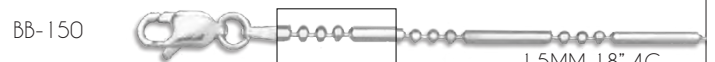
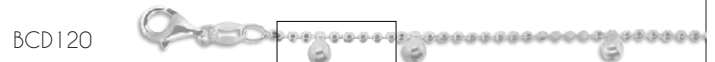
CHARM LINK

	GML60
4.3MM 7" 4G	
	GML70
5.3MM 7" 6.44G	

	*PC-1
1.8MM 18" 3G	
	DISCO25
1.5MM 18" 2.60G	
	BIS-50
3MM 18" 6.90G	
	SNAIL60
3MM 18" 8.60G	
	ANK100
3.6MM 18" 11.20G	
	ANK120
4.6MM 18" 16.06G	
	HE-1
6MM 18" 8.5G	

	BB-150
1.5MM 18" 4G	
	BCD120
3.5MM 18" 3.03G	
	ROLO-30-2C-SS
1.5MM 18" 2.5G	
	TS-2
2.3MM 18" 6G	
	TS-1
3MM 18" 6.60G	
	TM-2
1.6MM 18" 2.80G	
	TM-1
2.2MM 18" 5.20G	

OMEGA-F4
OMEGA-TT6-LOCK-R

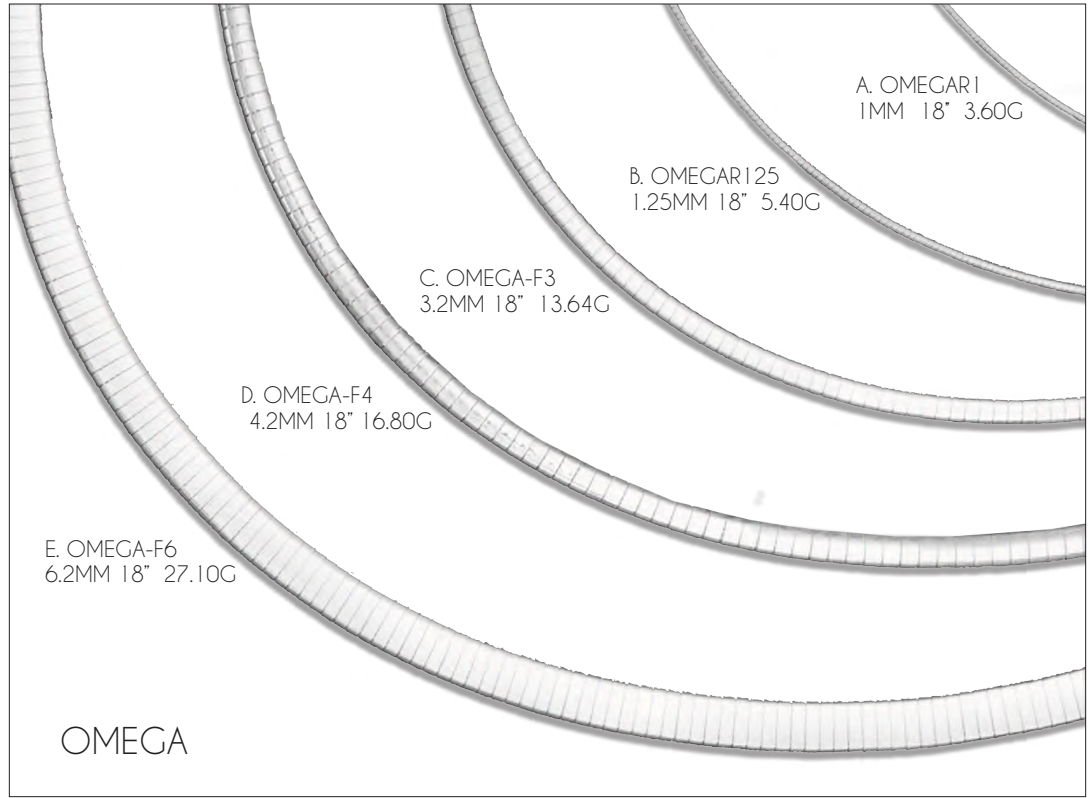

A. OMEGAR1
1MM 18" 3.60G

B. OMEGAR125
1.25MM 18" 5.40G

C. OMEGA-F3
3.2MM 18" 13.64G

D. OMEGA-F4
4.2MM 18" 16.80G

E. OMEGA-F6
6.2MM 18" 27.10G

OMEGA

OMEGA

TWO-TONE OMEGA CHAIN

OMEGA-TT2 2.5MM 18" 11.3G
OMEGA-TT3 3.3MM 18" 14G
OMEGA-TT4 4MM 18" 16G
OMEGA-TT6 6MM 18" 27.1G

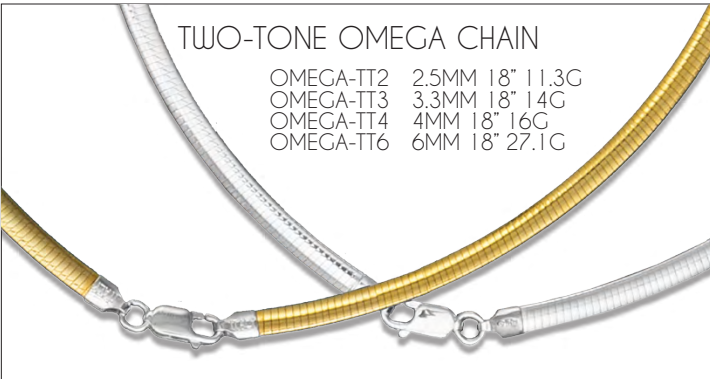

OMEGA-TT-R-2 2.5MM 18" 9.7G
OMEGA-TT-R-4 4MM 18" 16.5G



OMEGA CHAIN MEASUREMENTS
ARE APPROXIMATE.
ALL OMEGA CHAINS ARE MADE IN ITALY.

TWO-TONE OMEGA CHAIN W/ FANCY CLASP



OMEGA-TT6-LOCK
6MM 18" 24.01G



OMEGA-TT6-LOCK-R
6MM 18" 24.05G

OMEGA CHAINS ARE AVAILABLE IN 6MM
PROUDLY MADE IN ITALY

TWO-TONE OMEGA

	HB40
3.5MM 18" 7.14G	
	HB60
5.5MM 18" 15.90G	
	HB80
6.8MM 18" 17.44G	









LOOKING FOR GOLD VERMEIL HERRINGBONE
CHAINS? CHECK OUT PAGE 12.

HB80-16
HB60-C-18

HERRINGBONE

RHODIUM PLATED FIGARO

	FIG50-RH
1.8MM 18" 3.40G	
	FIG80-RH
3MM 18" 7.40G	
	FIG100-RH
3.9MM 18" 10.30G	
	FIG120-RH
4.8MM 18" 14.30G	
	FIG150-RH
5.8MM 24" 28.10G	
	FIG180-RH
8MM 24" 43G	
	FIG220-RH
8.4MM 24" 59.30G	

RHODIUM PLATED CURB

	GD35-RH
1.2MM 18" 2.10G	
	GD50-RH
1.8MM 18" 3.80G	
	GD60-RH
2.1MM 18" 5.40G	
	GD80-RH
2.8MM 18" 7.40G	
	GD100-RH
3.6MM 18" 12.70G	
	GD120-RH
4.2MM 18" 16.90G	
	GD150-RH
5.5MM 24" 33.90G	
	GD180-RH
6.7MM 24" 49.20G	
	GD220-RH
8.2MM 24" 65G	
	GD250-RH
9.5MM 24" 82.60G	

RHODIUM PLATED ASSORTED CHAINS

	ROLO10-RH	1MM 18" 0.90G
	ROLO-OV40-RH	1.5MM 18" 2.60G
	DCBALL-180-RH	1.8MM 18" 3.94G
	BOX15-RH	0.9MM 18" 2.10G
	BOX19-RH	1MM 18" 2.61G
	BOX24-RH	1.2MM 18" 3.90G
	BOX28-RH	1.5MM 18" 5.50G
	SING25-RH	1.5MM 18" 1.60G
	SING40-RH	2.5MM 18" 3.90G
	SNAKE25-RH	1MM 18" 4.30G
	SPIGA35-RH	1.5MM 18" 3.50G
	SPIGA50-RH	1.8MM 18" 5.40G
	ROPE40-RH	2MM 18" 6.13G
	*PC-I-RH	1.8MM 18" 4.16G
	SAT-I-RH	1.8MM 18" 2.7G
	*DCLO-RH	7.3MM 24" 9.37G
	*HDCL-RH	7MM 24" 15.40G

RHODIUM PLATED MIAMI CUBAN CURB

	CGD180-RH	6.2MM 22" 54.40G
	CGD220-RH	7.7MM 22" 78.80G

RHODIUM PLATED FRANCO

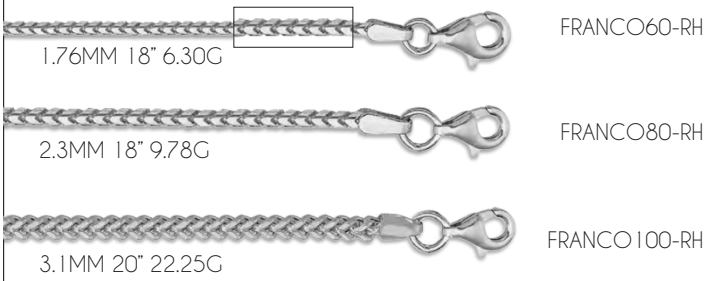

RHODIUM PLATED CHAINS



BLACK RHODIUM



BLACK RHODIUM AND ADJUSTABLE CHAINS

	SCD-190CW
2.1MM 18" 6.80G	
	DCBALL-180-G
1.8MM 18" 3.580G	
	BOX15-G
0.9MM 18" 1.92G	
	BOX19-G
1MM 18" 2.50G	
	*PC-1-G
1.8MM 18" 4.20G	
	SING40-G
2.5MM 18" 3.80G	
	SNAKE25-G
1MM 18" 4.10G	
	DISCO35-G
1.8MM 18" 4.50G	
	SPIGA35-G
1.5MM 18" 3.60G	
	ROLO-30-2C-G
1.5MM 18" 2.50G	
	ROLO10-G
1MM 18" 0.70G	
	ROLO-OV40-G
1.5MM 18" 2.60G	
	SAT1-G
1.8MM 18" 2.5G	
	*DCLO-G
7.3MM 24" 6.40G	
	*HDCL-G
7MM 24" 15.10G	

GOLD VERMEIL HERRINGBONE

HB40-G		3.5MM 18" 7.08G
HB60-G		5.5MM 18" 9.90G

GOLD VERMEIL PAPERCLIP

*PPC80-G		3MM 18" 7.08G
PPC120-G		4.3MM 18" 13.5G

GOLD VERMEIL FIGARO

FIG140-G		5.8MM 18" 14.5G
FIG160-G		6.5MM 22" 21.70G
FIG180-G		7.7MM 22" 26.80G



GOLD VERMEIL ROPE



ROSE GOLD VERMEIL CHAIN

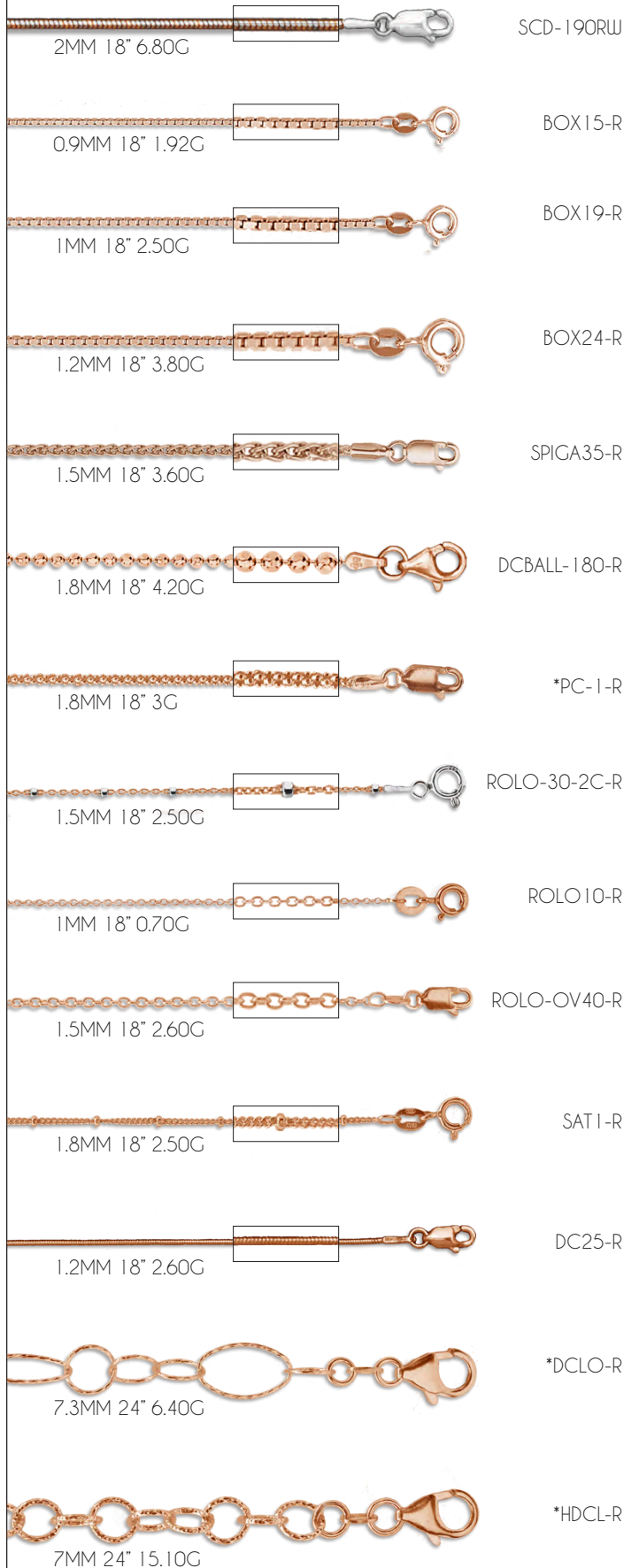

GOLD VERMEIL CURB



BOX24-R
P-1410-R-F





- A. GD-80-MED-RH
- B. GD-100-MED-RH
- C. GD-120-MED-RH
- D. GD-150-MED-RH
- E. GD-180-MED-RH
- F. GD-220-MED-RH
- G. GD-250-MED-RH



- A. FIG-80-MED-RH
- B. FIG-100-MED-RH
- C. FIG-120-MED-RH
- D. FIG-150-MED-RH
- E. FIG-180-MED-RH
- F. FIG-220-MED-RH
- G. FIG-250-MED-RH



- A. ID-GD-100-RH
- B. ID-GD-120-RH
- C. ID-GD-150-RH
- D. ID-GD-180-RH
- E. ID-GD-220-RH
- F. ID-GD-250-RH
- G. ID-GD-300-RH
- H. ID-GD-350-RH
- I. ID-GD-400-RH



- A. ID-FIG-100-RH
- B. ID-FIG-120-RH
- C. ID-FIG-150-RH
- D. ID-FIG-180-RH
- E. ID-FIG-220-RH
- F. ID-FIG-250-RH
- G. ID-FIG-300-RH
- H. ID-FIG-350-RH
- I. ID-FIG-400-RH

MOST ID BRACELETS ARE AVAILABLE EITHER IN 7", 7.5", 8", 8.5", 9" OR 10". ALL WEIGHTS ARE APPROXIMATE. QUOTES APPLY TO THE LENGTH SHOWN. ALL BRACELETS ARE RHODIUM PLATED.

A close-up photograph of a person's ear, showing a heart-shaped hoop earring. The background is a soft, out-of-focus white. A semi-transparent white box is overlaid on the right side of the image, containing text.

EARRINGS

HALO STUDS P. 37

SANDBLASTED STUDS P. 37

FRESHWATER PEARL STUDS P. 37

EAR JACKETS P. 37

CLASSIC STUDS P. 38

ASSORTED EARRINGS P. 39

LOVE KNOTS P. 39

CZ SCREWBAC STUDS P. 39

TRENDY CZ STUDS P. 40

TRENDY PLAIN STUDS P. 41

LEVERBACK EARRINGS P. 42

EAR CLIMBERS P. 42

THREADER EARRINGS P. 43

ANTI-TARNISH D/C EARRINGS P. 43

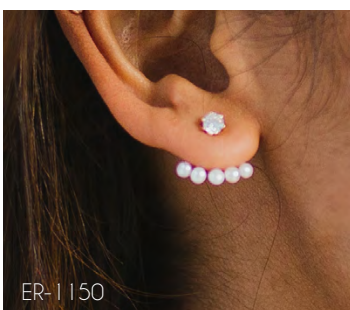
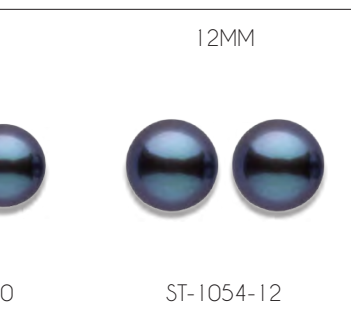
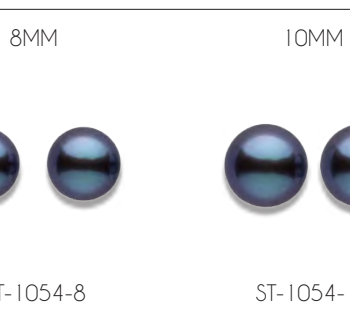
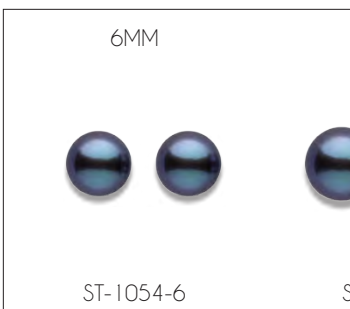
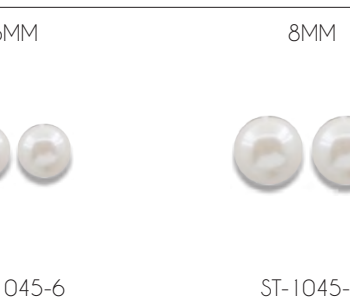
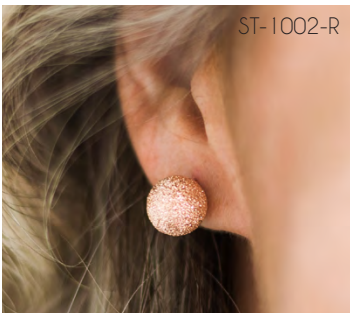
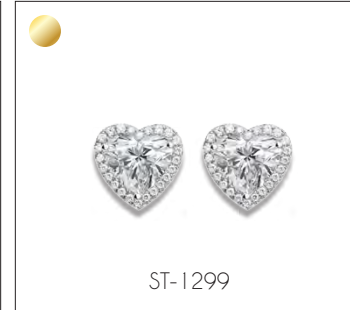
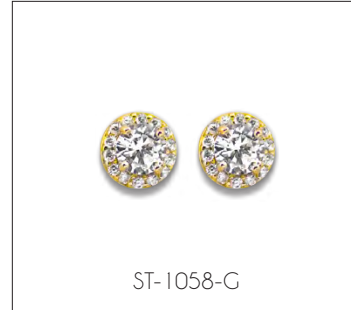
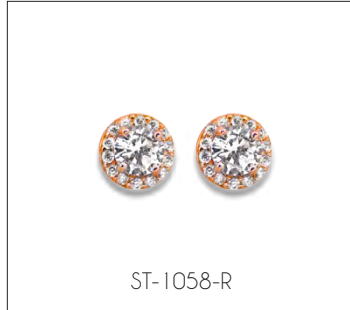
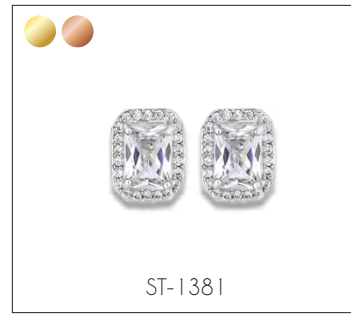













HALO STUDS





SANDBLASTED STUDS

FRESHWATER PEARL STUDS

EAR JACKETS

ST-1014-2		2MM
ST-1014-2.5		2.5MM
ST-1014-3		3MM
ST-1014-4		4MM
		
ST-1014-5		5MM
		
ST-1014-6		6MM
		
ST-1014-7		7MM
ST-1014-8		8MM
ST-1014-9		9MM
ST-1014-10		10MM







ROUND PRONG SET CZ STUDS

	ST-1026-R		
	ST-1026-6R		6MM
	ST-1026-8R		8MM
	ST-1026-10R		10MM

ROSE AND GOLD VERMEIL BALL STUDS

ST-1015-3		3MM
ST-1015-4		4MM
ST-1015-5		5MM
ST-1015-6		6MM
ST-1015-7		7MM
ST-1015-8		8MM

BEZEL SET CZ STUDS

	ST-1028-RH		
		RH PLATED	
	ST-1028-3RH		3MM
	ST-1028-4RH		4MM
	ST-1028-5RH		5MM
	ST-1028-6RH		6MM
	ST-1028-8RH		8MM
	ST-1028-10RH		10MM











RHODIUM PLATED BALL STUDS

ST-1016-3		3MM
ST-1016-4		4MM
ST-1016-5		5MM
ST-1016-6		6MM
ST-1016-7		7MM
ST-1016-8		8MM
ST-1016-9		9MM
ST-1016-10		10MM

PRINCESS CUT STUDS

ST-1017-3		4MM
ST-1017-4		4MM
ST-1017-5		5MM
ST-1017-6		6MM
ST-1017-7		7MM
ST-1017-8		8MM

PRONG SET BLACK CZ STUDS

ST-1003-2		2MM
ST-1003-3		3MM
ST-1003-4		4MM
ST-1003-5		5MM
ST-1003-6		6MM
ST-1003-7		7MM
ST-1003-8		8MM
ST-1003-9		9MM
ST-1003-10		10MM
ST-1003-12		12MM

BALL STUDS



ST-1018-3		3MM
ST-1018-4		4MM
ST-1018-5		5MM
ST-1018-6		6MM
ST-1018-7		7MM
ST-1018-8		8MM

BLACK CZ PRINCESS CUT STUDS



ST-1455



ST-1453-B



ST-1453-R



ST-1341

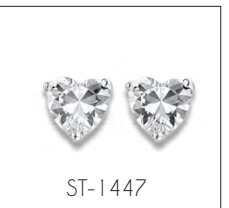

ST-1447

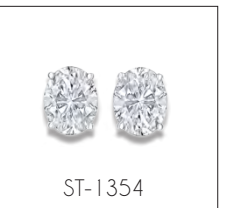

ST-1354



ST-1182-8



ST-1334-5

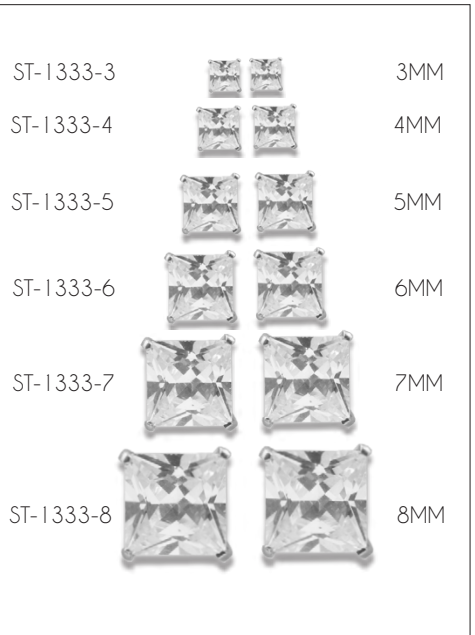
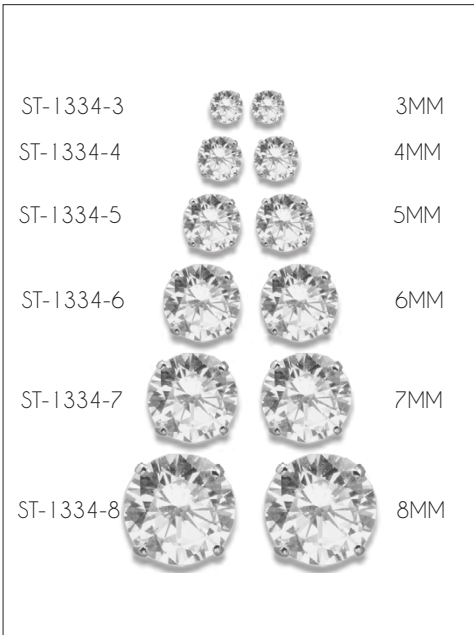
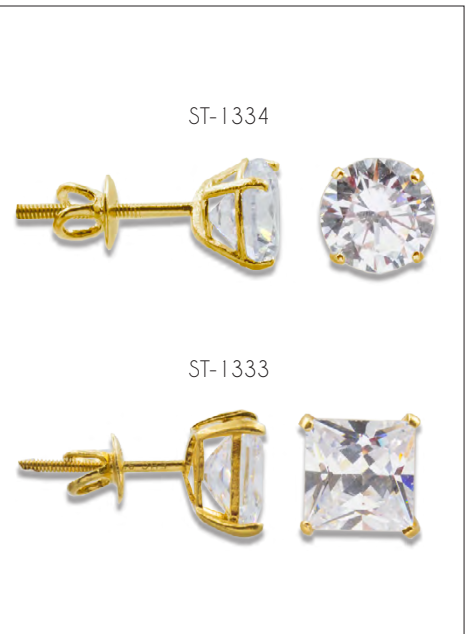
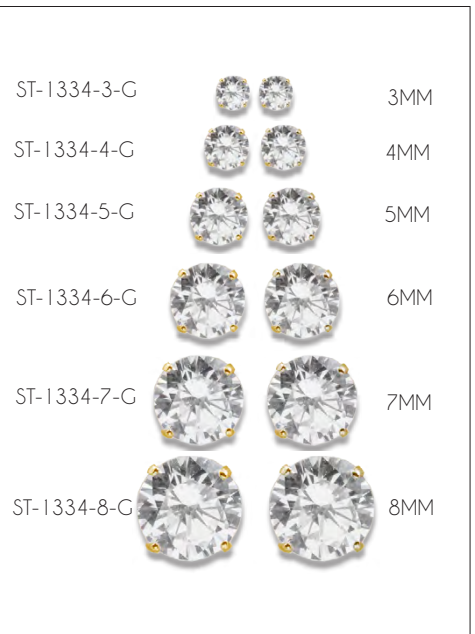

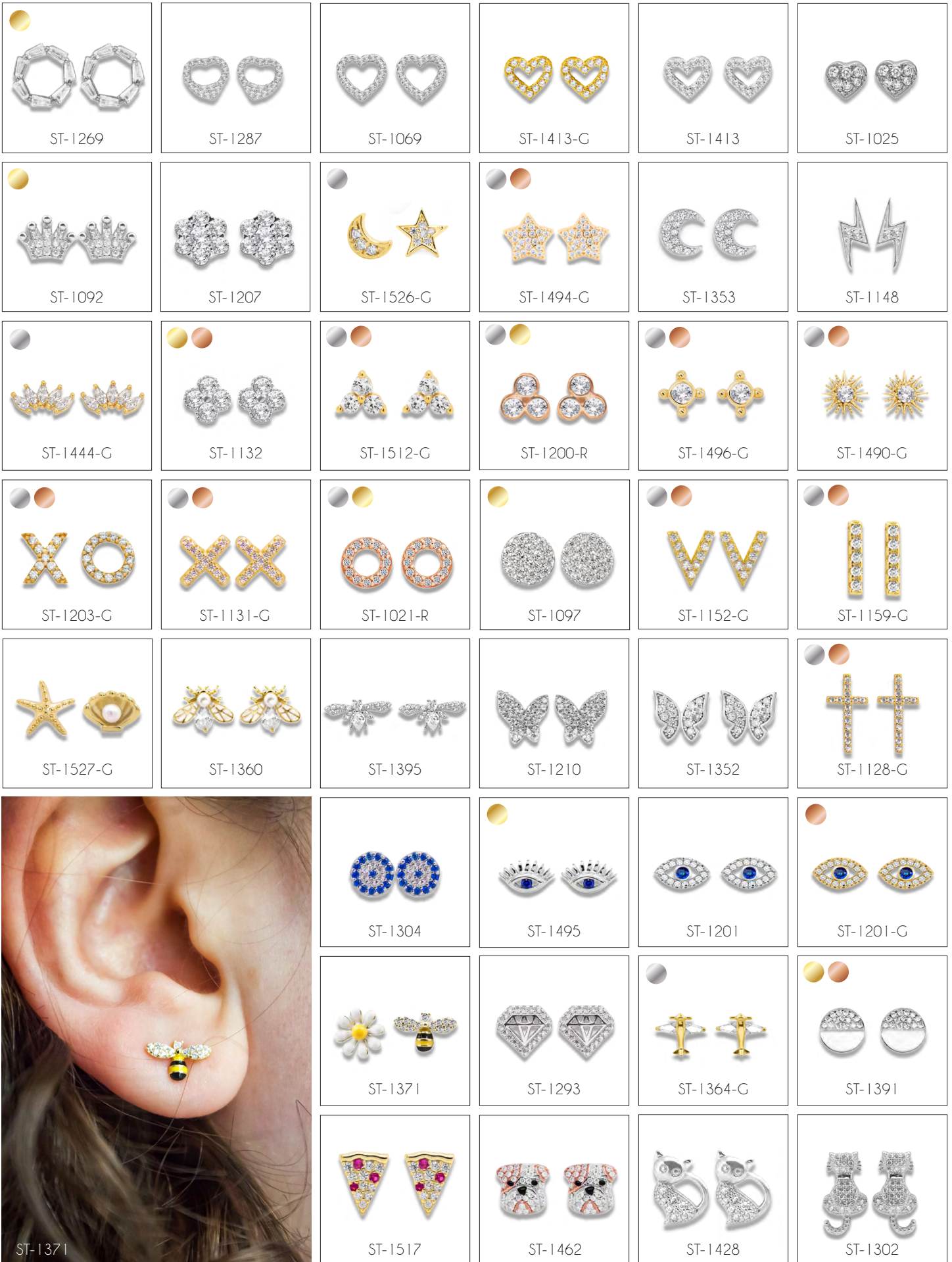

ST-1269



ST-1287



ST-1069



ST-1413-G



ST-1413



ST-1025



ST-1092



ST-1207



ST-1526-G



ST-1494-G



ST-1353



ST-1148



ST-1444-G



ST-1132



ST-1512-G



ST-1200-R



ST-1496-G



ST-1490-G



ST-1203-G

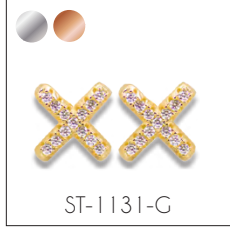

ST-1131-G



ST-1021-R



ST-1097



ST-1152-G



ST-1159-G



ST-1527-C



ST-1360



ST-1395



ST-1210



ST-1352



ST-1128-G



ST-1371



ST-1304



ST-1495

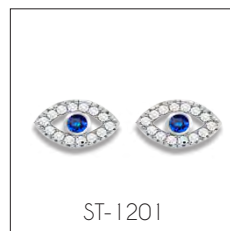

ST-1201



ST-1201-G



ST-1371



ST-1293



ST-1364-G



ST-1391



ST-1517



ST-1462



ST-1428



ST-1302

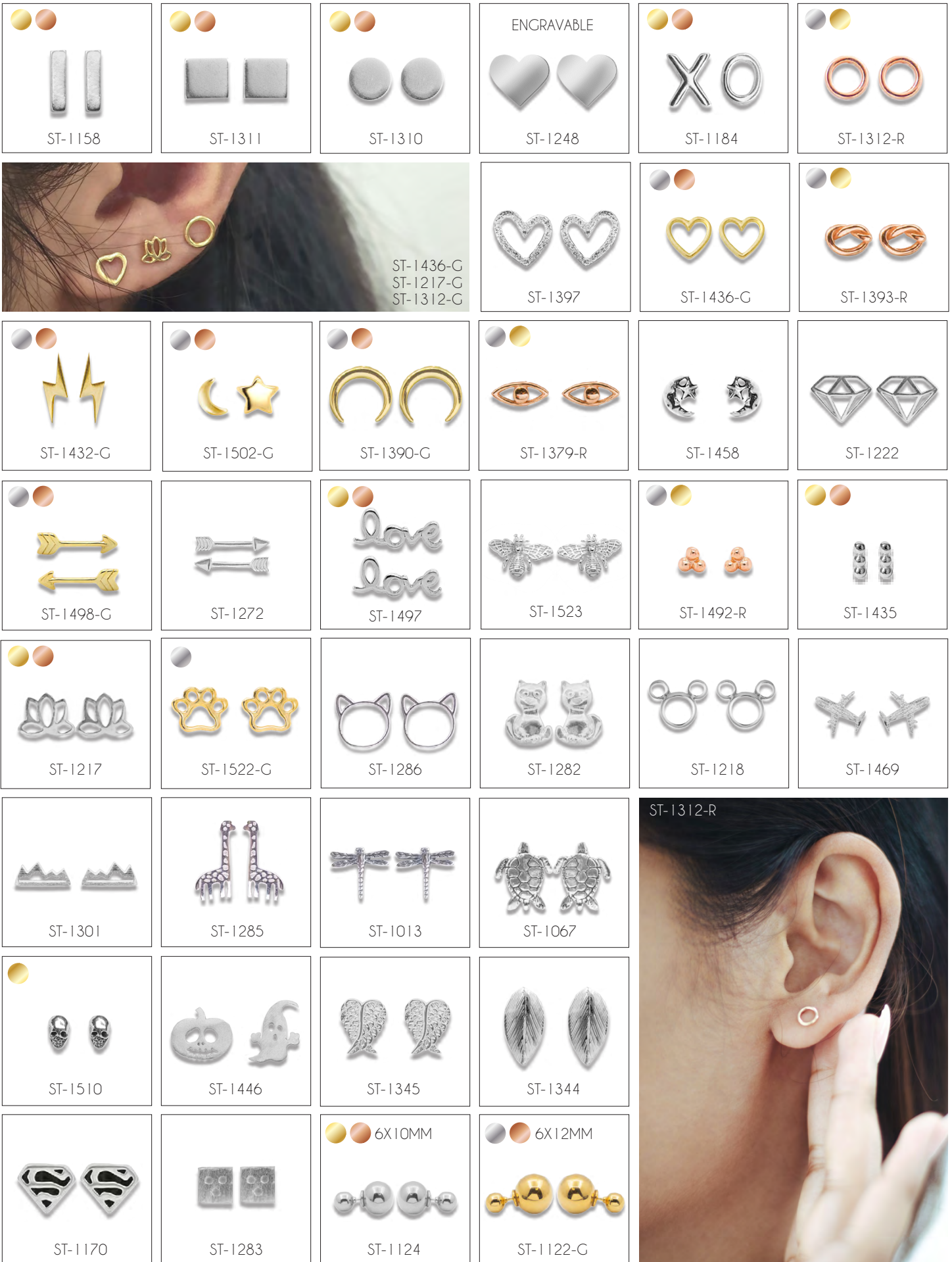

LEVERBACK EARRINGS

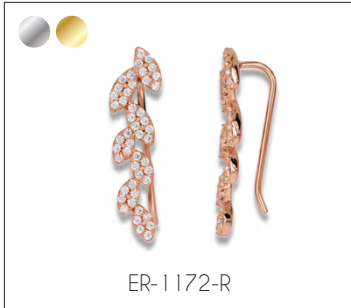
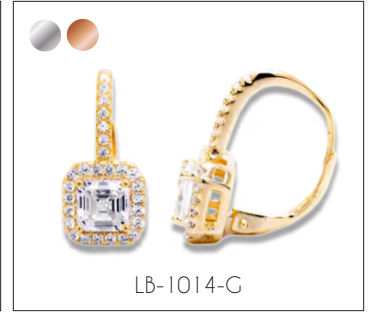

EAR CLIMBERS





ER-1344-G



ER-1345-G



ER-1342-G



ER-1324-G

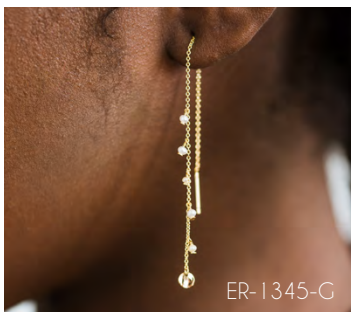

ER-1345-G



1.90G

ED1012



1.24G

ED1337P



3.80G

ESD147



4.20G

ED4340



2.50G

ED4358



6.70G

ESD214



3.20G

ANE130



1.93G

ED4337



2.40G

ED4687P



5.30G

ED1269



3.3G

ED1266



3.9G

ED3740



3.67G

ED4360



2.70G

ED3043



5.60G

ESD132



3.3G

ED1112



HOOPS

PLAIN HUGGIES P. 45

CZ HUGGIES P. 45 - 46

BALI HOOPS P. 46

TUBE HOOPS P. 47 - 50

D/C HOOPS P. 50

CZ HOOPS P. 50

TRENDY HOOPS P. 51



HUG-1001



HUG-1002



HUG-1069



HUG-1040



HUG-1061-G-L



HUG-1061-S



HUG-1050-G



HUG-1067-G



HUG-1047



HUG-1044-G

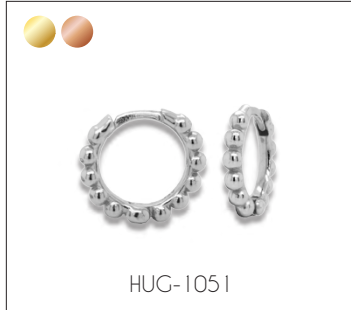

HUG-1051

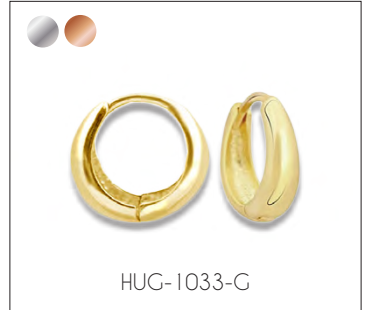

HUG-1033-G



HUG-1046
HUG-1046-R



HUG-1046



HUG-1058-G



HUG-1010



HUG-1012



HUG-1007



HUG-1008



HUG-1016



HUG-1041



HUG-1009



HUG-1006



HUG-1027-R



HUG-1035



HUG-1038



HUG-1043



HUG-1048-G



HUG-1037-G



HUG-1045



HUG-1036-R



10MM

BH-1001



10MM

BH-1002



10MM

BH-1003

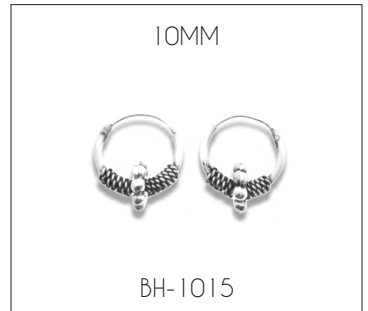

10MM

BH-1015



12MM

BH-1004



12MM

BH-1005



12MM

BH-1006



12MM

BH-1007



14MM

BH-1008



14MM

BH-1009



14MM

BH-1010



16MM

BH-1011



BH-1011



20MM

BH-1012



20MM

BH-1013



20MM

BH-1014

*1.25MM SLEEPERS

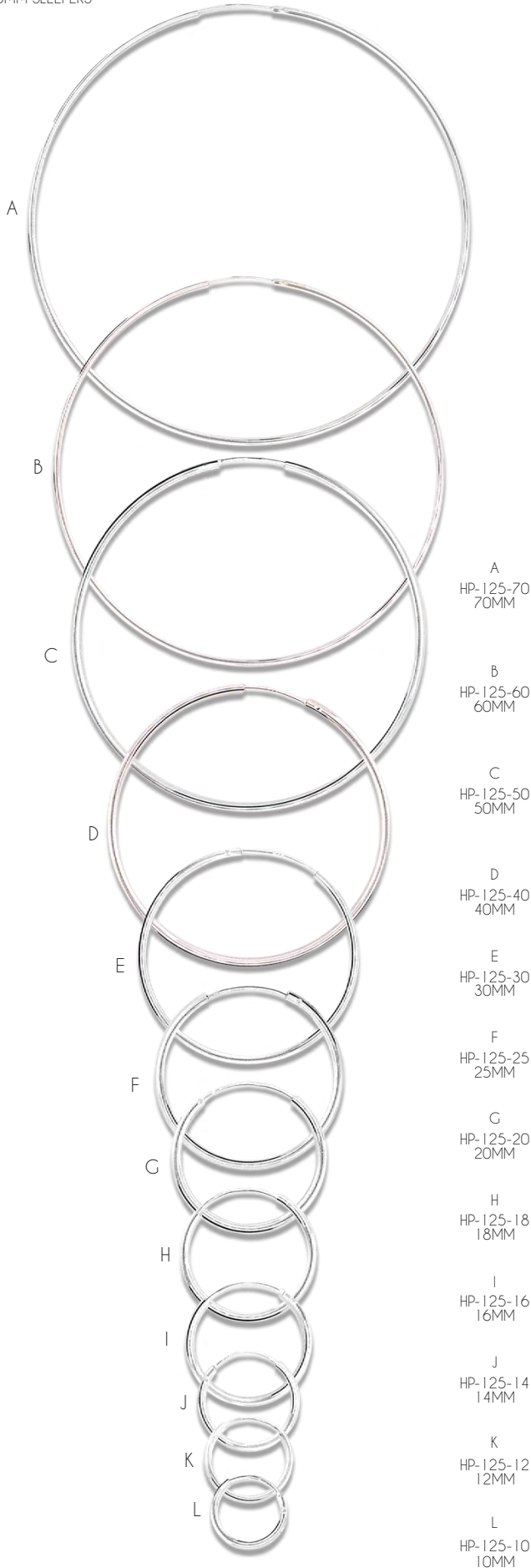

*2MM TUBE HOOPS

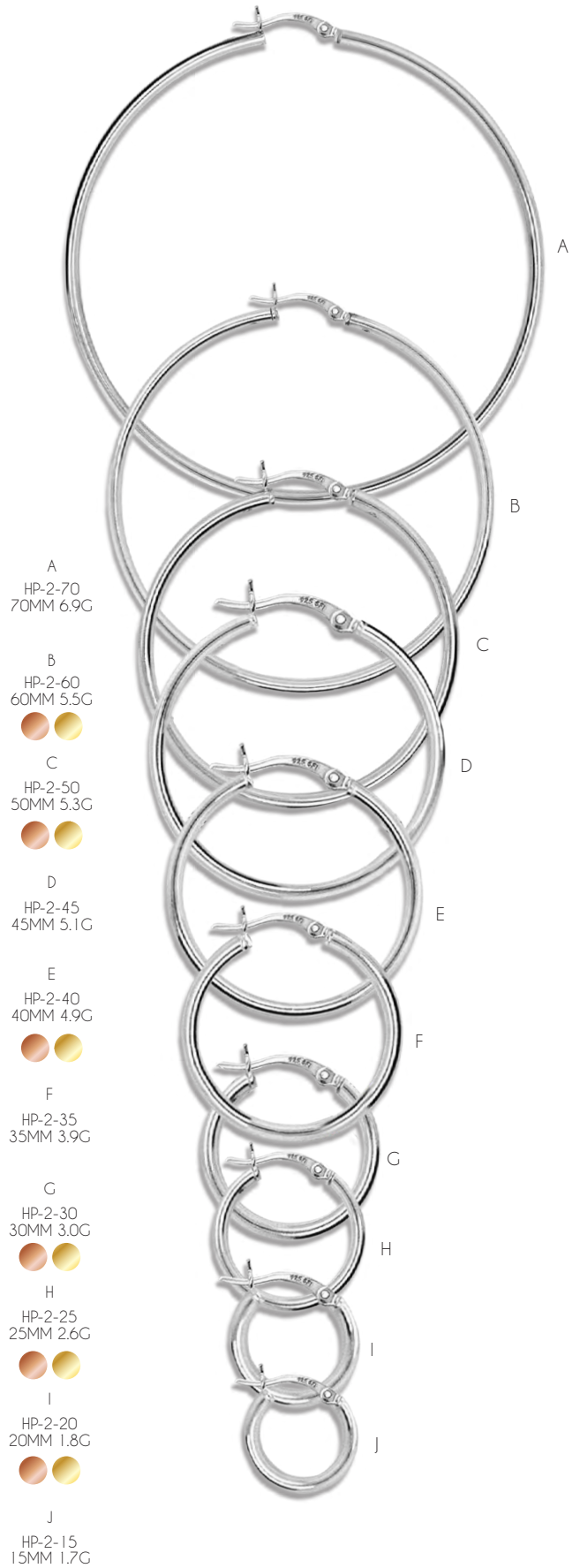



HP-225-60

*2.25MM TUBE HOOPS

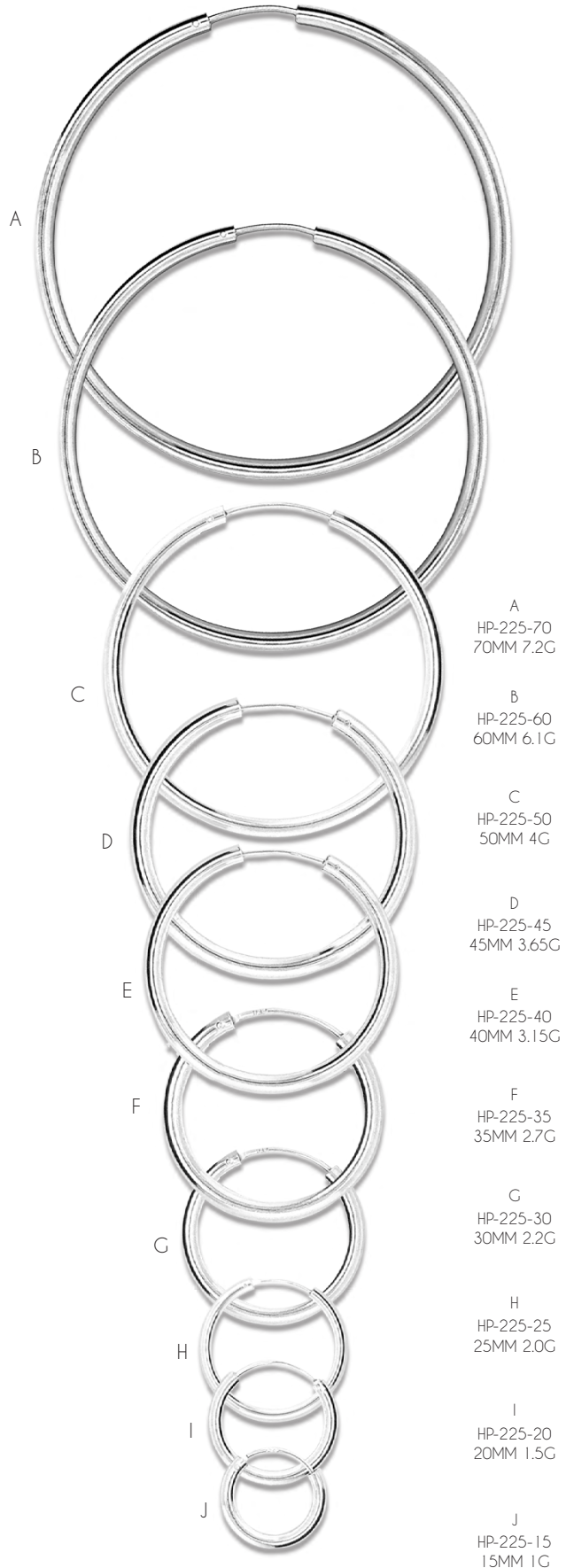



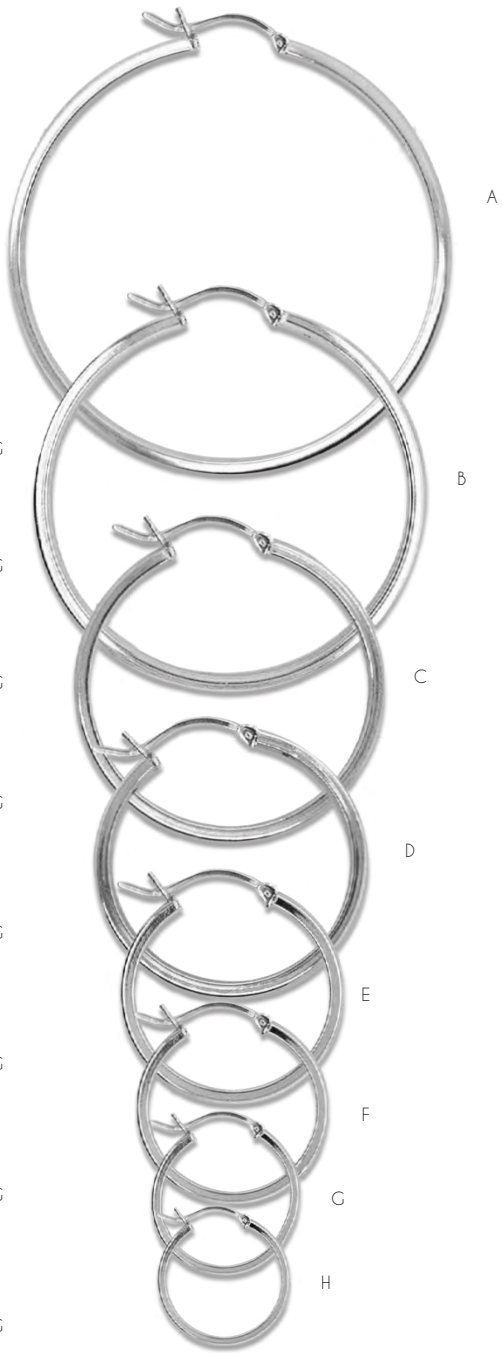

*2.5MM TUBE HOOPS

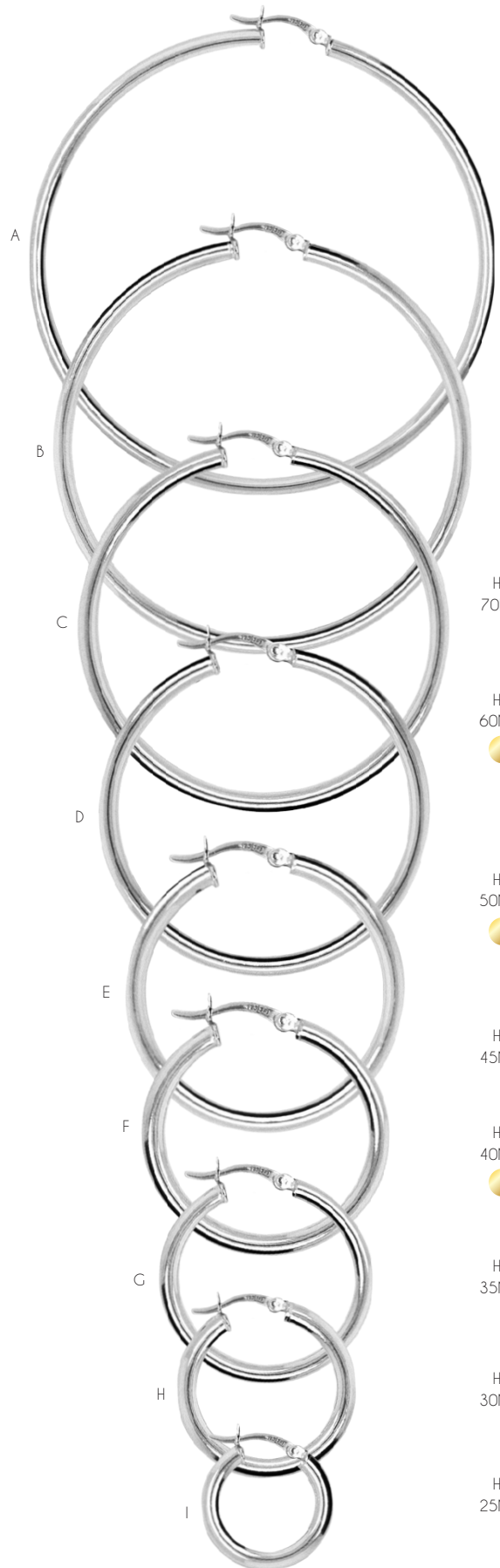

- A
HP-250-60
60MM 7.1G
- B
HP-250-50
50MM 5.6G
- C
HP-250-40
40MM 4.3G
- D
HP-250-35
35MM 3.9G
- E
HP-250-30
30MM 3.0G
- F
HP-250-25
25MM 2.6G
- G
HP-250-20
20MM 2.3G
- H
HP-250-15
15MM 1.6G

*3MM TUBE HOOPS



- A
HP-3-70
70MM 10G
- B
HP-3-60
60MM 8.8G

- C
HP-3-50
50MM 7.4G

- D
HP-3-45
45MM 7.0G
- E
HP-3-40
40MM 5.9G

- F
HP-3-35
35MM 5.2G
- G
HP-3-30
30MM 4.2G
- H
HP-3-25
25MM 3.5G
- I
HP-3-20
20MM 2.4G



HP-3-50-RC

TUBE HOOPS



*4MM TUBE HOOPS

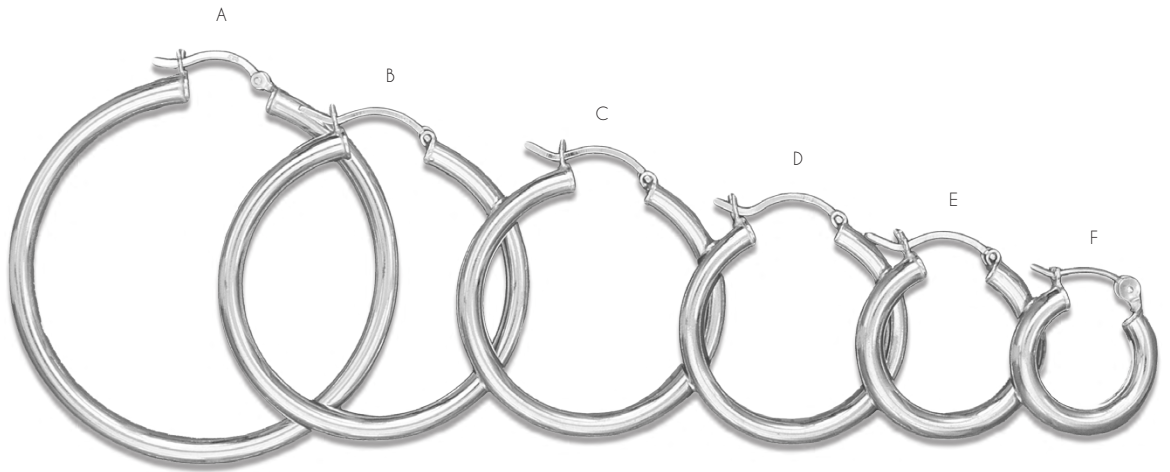

- | | | | | | |
|-----------------------|---------------------|----------------------|----------------------|----------------------|----------------------|
| A | B | C | D | E | F |
| HP-4-50
50MM 12.2G | HP-4-40
40MM 10G | HP-4-35
35MM 8.3G | HP-4-30
30MM 6.9G | HP-4-25
25MM 5.3G | HP-4-20
20MM 3.9G |

D/C HOOPS

*DIAMOND CUT

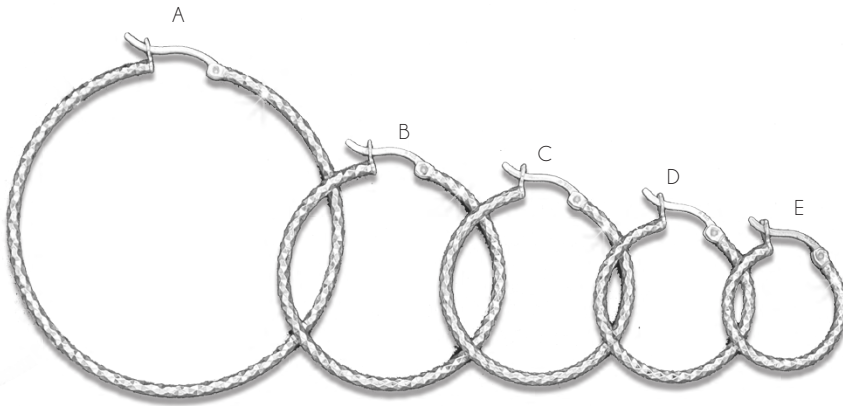

- | | | | | |
|-----------------------|-----------------------|-----------------------|-----------------------|-----------------------|
| A | B | C | D | E |
| HP-DC-45
45MM 4.5G | HP-DC-30
30MM 3.0G | HP-DC-25
25MM 2.5G | HP-DC-20
20MM 2.1G | HP-DC-15
15MM 1.6G |

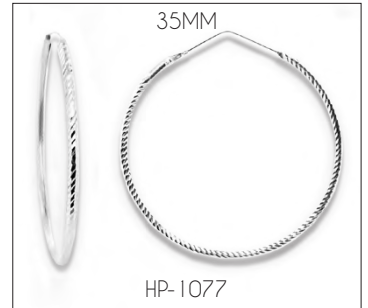

CZ HOOPS

HP-CZ-1039-50



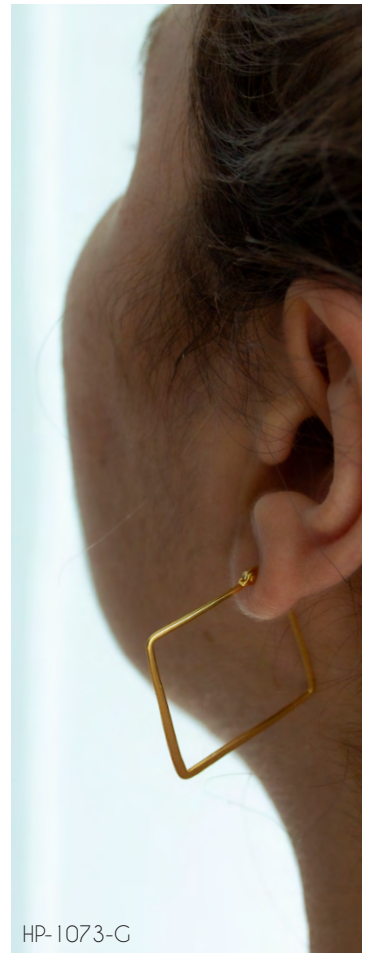
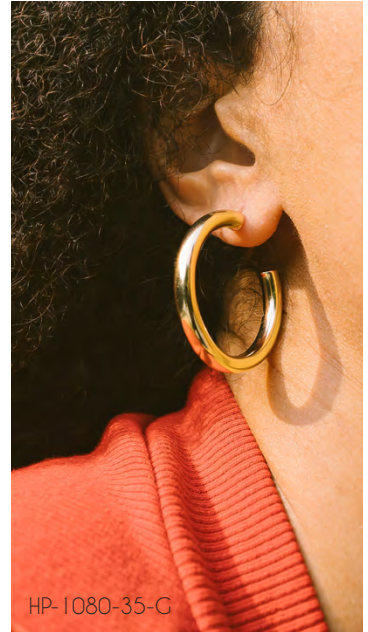
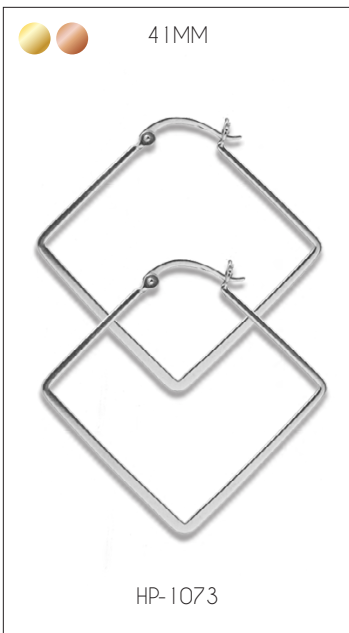
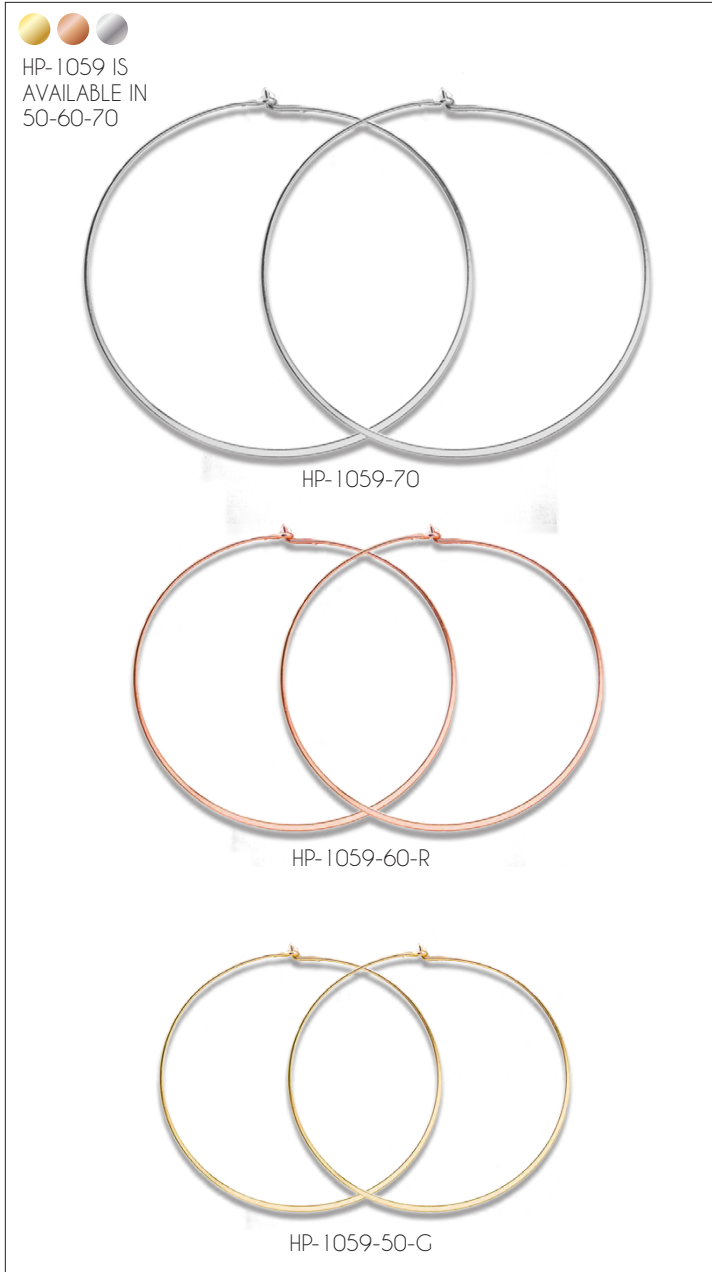
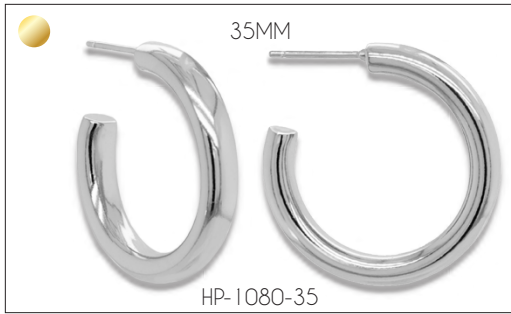

TRENDY HOOPS



RINGS

PLAIN RINGS P. 53

SIGNET RINGS P. 53

TRENDY CZ RINGS P. 54

CZ BAND RINGS P. 54

ENGAGEMENT SETS P. 55

TRADITIONAL CZ RINGS P. 55

COCKTAIL RINGS P. 55

EMULATED STONE CZ COLOURFUL RINGS P. 56

DAVID YURMAN INSPIRED RINGS P. 56

BAND RINGS P. 57

FLAT BAND RINGS P. 57

TIFFANY BAND RINGS P. 57

ROLO RINGS P. 57

MOVEABLE RING P. 57

PUZZLE RINGS P. 57

POISON RINGS P. 57

CLADDAUGH RINGS P. 57



R-1345-G



R-1325-G



R-1586



R-1428

R-1497-G



R-1590-G



R-1581-G



R-1571



R-1571-G



R-1499



R-1499-G



R-1499-R



R-1460

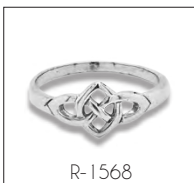

R-1568

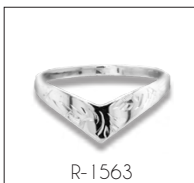

R-1563



R-1531



R-1418



R-1418-G



R-1418-R



R-1540



R-1538



R-1434



R-1205



R-1193



R-1497



R-1589-G



R-1548-G



R-1245
R-1391
R-1376



R-1548



R-1548-G



R-1587-G



R-1127



R-1203



R-1376



R-1245



R-1391



R-1204

PLAIN RINGS

SIGNET RINGS

MOST RINGS ARE AVAILABLE IN SIZES 5, 6, 7, 8, & 9. WE DO NOT CARRY HALF SIZES.

TRENDY CZ RINGS



R-1427
R-1459



R-1490-G

CZ BAND RINGS

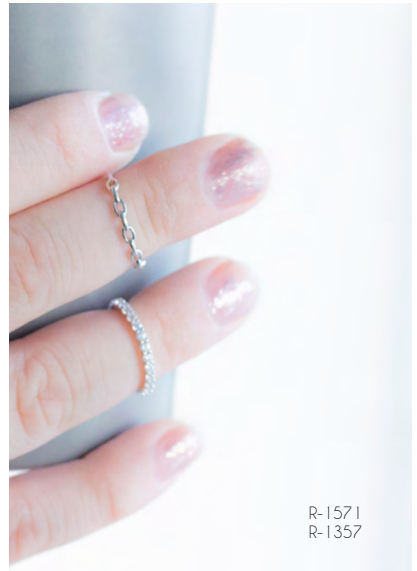

R-1571
R-1357



R-1558



R-1558



R-1560



R-1487



R-1478



R-1481



R-1180



R-1526



R-1385



R-1515



R-1389



R-1464



R-1223



R-1514



R-1476



R-1512

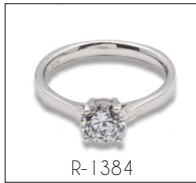

R-1384



R-1340



R-1381



R-1417



R-1464



R-1465



R-1341



R-1480



R-1379



R-1513



R-1486



R-1518



R-1351



R-1464
R-1466
R-1465



R-1353



R-1321

R-1320

R-1210

R-1353

<p>WHITE CUBIC ZIRCONIA</p>  <p>R-1034-W-ADJ</p>	<p>SAPPHIRE</p>  <p>R-1034-S-ADJ</p>	<p>EMERALD</p>  <p>R-1034-E-ADJ</p>	<p>GARNET</p>  <p>R-1034-G-ADJ</p>	<p>RUBY</p>  <p>R-1034-R-ADJ</p>	<p>AMETHYST</p>  <p>R-1034-A-ADJ</p>	<p>TOURMALINE</p>  <p>R-1556</p>
<p>ROSE QUARTZ & WHITE TOPAZ</p>  <p>R-1576</p>	<p>TURQUOISE</p>  <p>R-1419-T</p>	<p>PEARL</p>  <p>R-1577-G</p>	<p>CORAL</p>  <p>R-1347-G</p>	<p>SAPPHIRE</p>  <p>R-1473</p>	<p>SAPPHIRE</p>  <p>R-1473-G</p>	<p>SAPPHIRE</p>  <p>R-1420-G</p>



 <p>R-1075-W</p>	 <p>R-1075-B</p>	 <p>R-1075-T</p>	 <p>R-1075-SH</p>	 <p>R-1075-M</p>
---	---	---	--	---





R-1548-G
R-1498-C



BAND RINGS

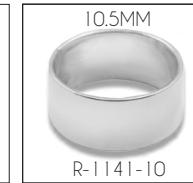

FLAT BAND RINGS



TIFFANY BAND RINGS



MOVEABLE RING



ROLO RINGS



POISON RINGS



PUZZLE RINGS

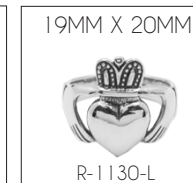
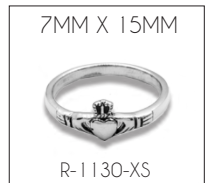

























CLADDAGH RINGS



PLAIN BAND RINGS ARE AVAILABLE IN STERLING SILVER, HOWEVER, RHODIUM PLATED RINGS CAN BE SPECIAL ORDERED FOR AN ADDITIONAL FEE. WHEN ORDERING BAND RINGS PLEASE INCLUDE THE WIDTH OF THE RING IN MILLIMETRES AND RING SIZE IN THAT ORDER (E.G. R-1140-5-8).

PENDANTS + LOCKETS

- PLAIN LOCKETS P. 59
- ENGRAVED LOCKETS P. 59 - 60
- ASSORTED LOCKETS P. 61
- URN LOCKETS P. 61
- ITALIAN LOCKETS P. 61
- CZ PENDANTS P. 62
- PLAIN PENDANTS P. 62
- CLASSIC PENDANTS P. 63
- ROYAL WEDDING SETS P. 63
- PENDANT SETS P. 63
- ASSORTED RELIGIONS P. 63
- PLAIN CROSSES P. 64
- CZ CROSSES P. 64
- ASSORTED MEDALLIONS P. 65
- SAINT CHRISTOPHER P. 65
- SAINT JOSEPH P. 65
- SAINT MICHAEL P. 65
- ROUND + OVAL DOG TAGS P. 66
- HEART DOG TAGS P. 66
- TRADITIONAL DOG TAGS P. 67
- MEDICAL PENDANTS P. 67

<p>13X13MM</p>  <p>LOC-RP-1025</p>	<p>15X20MM</p>  <p>LOC-OP-1020</p>	<p>26X20MM</p>  <p>LOC-OP-1019*</p>	<p>34X24MM</p>  <p>LOC-OP-1022</p>	<p>45X30MM</p>  <p>LOC-OP-1023</p>	
<p>23X23MM</p>  <p>LOC-RP-1024</p>	<p>18X15MM</p>  <p>LOC-OP-1061</p>	<p>20MMX20MM</p>  <p>LOC-PH-1044*</p>			
<p>11X11MM</p>  <p>LOC-PH-1040</p>	<p>23X23MM</p>  <p>LOC-PH-1036*</p>	<p>32X32MM</p>  <p>LOC-PH-1042</p>	<p>38MMX38MM</p>  <p>LOC-PH-1043</p>		
<p>16X15MM</p>  <p>LOC-PH-1037</p>					
<p>13X13MM</p>  <p>LOC-RE-1006</p>	<p>12X12MM</p>  <p>LOC-RE-1007</p>	<p>13X13MM</p>  <p>LOC-RE-1008</p>	<p>12X12MM</p>  <p>LOC-RE-1062</p>	<p>18X18MM</p>  <p>LOC-RE-1009</p>	<p>10X9MM</p>  <p>LOC-RE-1049</p>
<p>30X30MM</p>  <p>LOC-RE-1012</p>	<p>25X25MM</p>  <p>LOC-RE-1011</p>	<p>20X20MM</p>  <p>LOC-RE-1010</p>	<p>20X20MM</p>  <p>LOC-RE-1018</p>	<p>17X13MM</p>  <p>LOC-RE-1048</p>	

MOST LOCKETS ARE SHOWN CLOSE TO SCALE AND ARE AVAILABLE IN STERLING SILVER.
 * LOC-OP-1019, LOC-PH-1036, & LOC-PH-1044 ARE "FAMILY LOCKETS."

12X9MM



LOC-OE-1018

14X12MM



LOC-OE-1019

18X15MM



LOC-OE-1005

18X14MM



LOC-OE-1016

25X18MM



LOC-OE-1015

28X21MM



LOC-OP-1054

27X20MM



LOC-OE-1004

18X32MM



LOC-OE-1014

40X18MM



LOC-OE-1013

23X20MM



LOC-HE-1032*

11X11MM



LOC-HE-1028

13X13MM



LOC-HE-1036

45X41MM



LOC-HE-1034

25X25MM



LOC-PH-1073

16X16MM



LOC-HE-1030

13X13MM



LOC-HE-1029

28X28MM



LOC-HE-1033

21X21MM



LOC-HE-1031



LOC-OE-1015
 LOC-HE-1063
 LOC-OE-1018
 LOC-PH-1038
 LOC-HE-1032

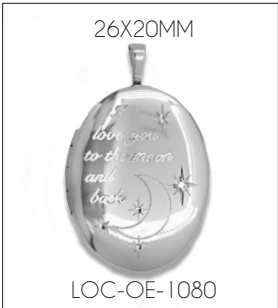
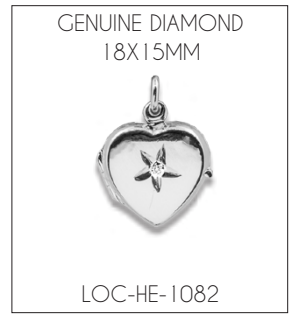

ASSORTED LOCKETS

URN LOCKETS

ITALIAN LOCKETS

MOST ITALIAN LOCKETS ARE RHODIUM PLATED AND HAVE A CLEAR PLASTIC PHOTO PROTECTOR.

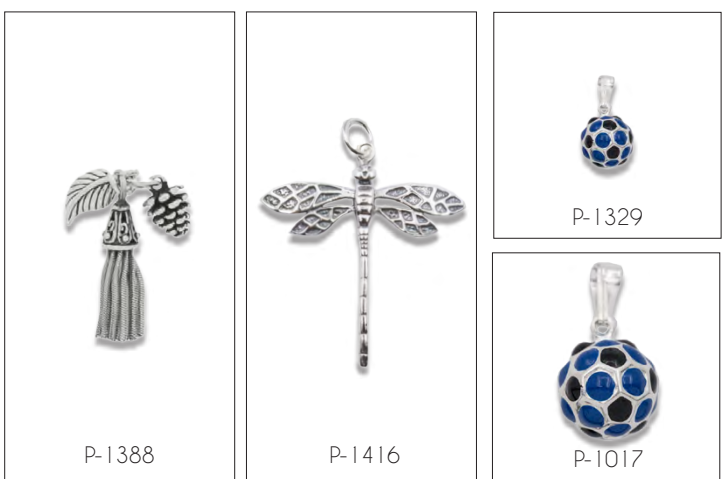
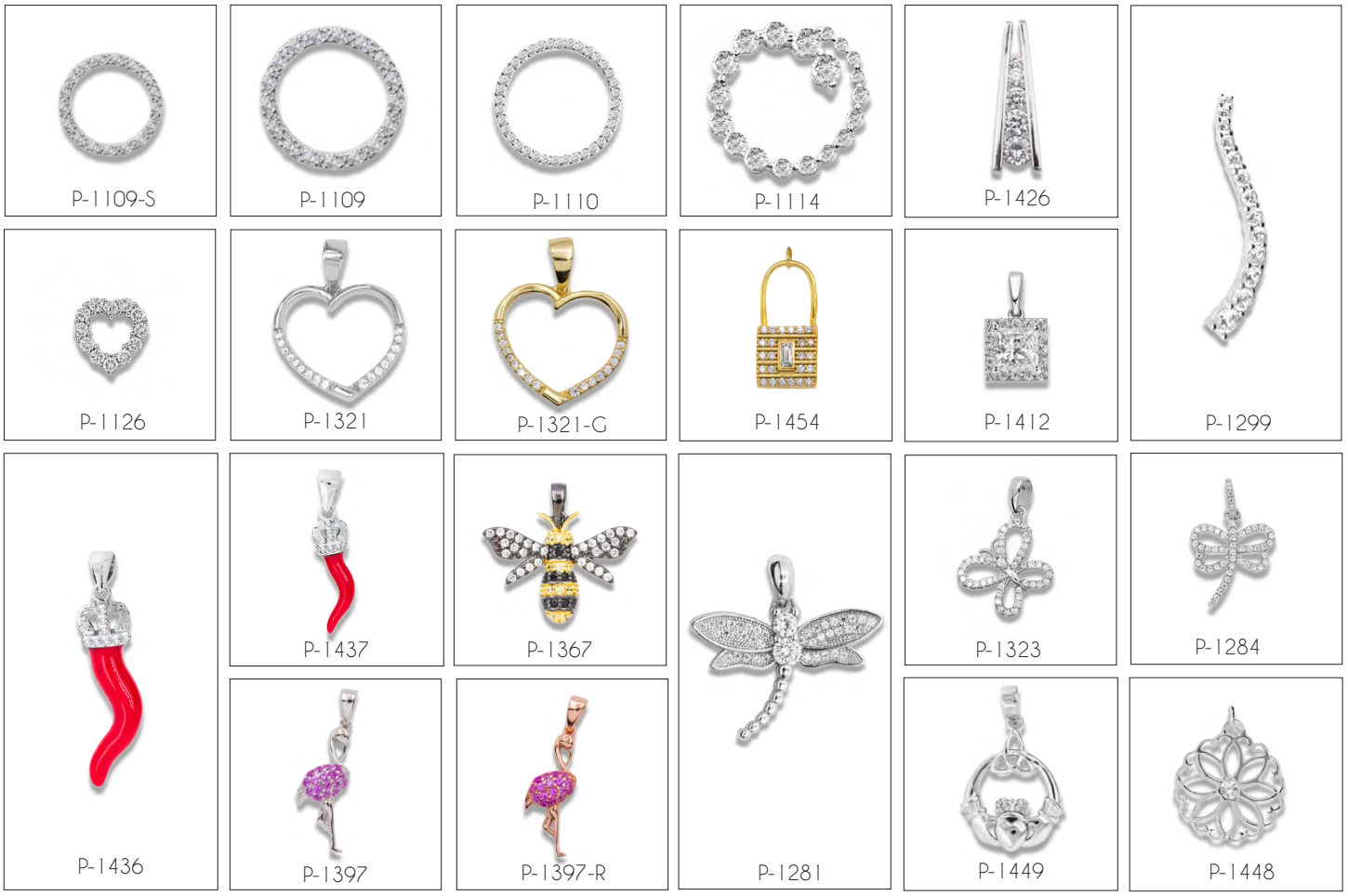

CLASSIC
PENDANTS

5MM	6MM	8MM	10MM	6MM	7MM	8MM	7MM
P-1102-5	P-1102-6	P-1102-8	P-1102-10	P-1103-6	P-1103-7	P-1103-8	P-1412

RUBY	GARNET	WHITE CUBIC ZIRCONIA	SAPPHIRE	EMERALD	AMETHYST
PS-1024-R	PS-1024-G	PS-1024-W	PS-1024-S	PS-1024-E	PS-1024-A

ROYAL WEDDING SETS



	WHITE MYSTIC TOPAZ			
PS-1050	PS-1060	PS-1051	PS-1023-W	

PENDANT SETS



P-1223	P-1237	P-1211	P-1212	P-1405	P-1405-R

ASSORTED RELIGIONS

MOST PENDANTS ARE SHOWN CLOSE TO SCALE.



15MM
FIRST HOLY COMMUNION



P-1287

*MIRACULOUS MEDALS



10MM
P-1024-10



12MM
P-1024-12

18MM
ST. JUDE THADDEUS



P-1267

18MM
SAINT FRANCIS



P-1285

18.5MM
SAINT LAZARUS



P-1269

15MM
CONFIRMATION



P-1286



15MM
P-1024-15



20MM
P-1024-20

18MM



P-1288



P-1286

ASSORTED MEDALLIONS

15X24MM
RH PLATED



P-1205

18X27MM
RH PLATED



P-1208

14MM



P-1207

16.5MM



P-1206

16MM



P-1204

20MM
RH PLATED



P-1423

25MM
RH PLATED



P-1425

SAINT CHRISTOPHER



P-1204



P-1425

15MM



P-1266

18MM



P-1266-L

SAINT JOSEPH

12MM



P-1261

15MM



P-1262

SAINT ANTHONY



P-1288

15MM



P-1264

19MM



P-1033

SAINT MICHAEL

ROUND & OVAL DOG TAGS

8X8MM  DT-C-122	12X12MM  DT-C-105	12X12MM  DT-C-105-G	12X12MM  DT-C-105-R	13X13MM  DT-C-102	17X17MM 13X13MM  DT-C-103	 20X20MM  DT-C-101
--	--	--	--	--	---	--



25X25MM  DT-C-100
--

15MM  DT-C-114	25MM  DT-C-104	15X21MM  DT-O-100	18X15MM 15X11MM  DT-O-103	16X16MM  P-1398
--	--	---	--	---

HEART DOG TAGS

12MM  DT-H-101-T	15MM  DT-H-100-T	10X12MM  DT-H-102	10X12MM  DT-H-102-G	10X12MM  DT-H-102-R
---	---	--	--	--



23X20MM  DT-H-105	15X15MM  DT-H-101	15X15MM  DT-H-101-G	15X15MM  DT-H-101-R	15X18MM 12X10MM  DT-H-103	15X18MM  P-1385
--	--	--	--	---	--

18X12MM



DT-103

27X15MM



DT-102

27X15MM
18X10MM



DT-104

31X18MM



DT-101

30X18MM



DT-108

35X18MM



DT-100

40X23MM



DT-112

38X25MM



DT-116

35X7MM



DT-106

20X15MM



DT-110

PS-1055



PS-1055



CHARMS

NAUTICAL P. 69

TALKING P. 70

SPORTS P. 71

ANIMALS P. 72

CHARM HOLDERS P. 73

ASSORTED P. 73

RELIGIOUS P. 74 - 75

JB135 1.2G 	JB176 1G 	JB148 2G 	JB417 2G 	JB213 2.4G 	JB249 2G 	JB146 2.4G
JB447 1.6G 	JB234 1.1G 	JB178 0.9G 	JB524 1.9G 	JB338 3.2G 	JB208 3.8G 	JB254 1.3G
JB351 2.2G 	JB238 1.4G 	JB361 2.7G 	JB483 1.5G 	JB570 3.4G 	JB317 2.1G 	
	C1437 2.8G 	JB207 1.2G 	JB233 2.8G 	JB210 2.2G 	JB349 1G 	
JB431 1.8G 	C2994 3.5G 	A2161 2.4G 	JB525 0.9G 	C3673 1.8G 	JB327 1G 	
JB267 1.2G 			JB472 1.8G 		JB474 1G 	
C4728 1.3G 	S178 1.4G 	C1349 2.3G 	JB179 1.8G 	JB496 1.2G 	JB510 2.9G 	
	C3103 1.1G 					
C2417 2.3G 	JB439 1.7G 		JB500 1.1G 	JB260 2.7G 		



C4845
S2293
C4732



C4845
2.6G



C3405
2.4G



C4256
2G



C3404
2.2G



C4738
1.9G



C4742
1.7G



C4739
1.7G



C4737
1.8G



C4736
1.2G



C3023
1.5G



S1963
1.1G



C4735
1.8G



C4729
0.9G



C4741
1.3G



C4740
1.2G



JB603
0.8G



JB256
0.8G



JB597
1G



S237
1.5G



C4733
1.5G



C4732
1.9G



C4252
2.3G



C4731
1.6G



S2293
1.5G



C4734
1.1G



C3404



S1657
1.5G



C4820
1.3G



S2233
1.1G



S1936
1.2G



S668
1.6G

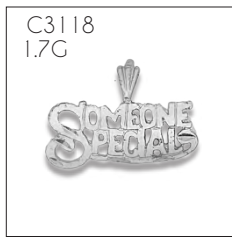

C3118
1.7G



TC1352
0.9G



JB583
1.4G









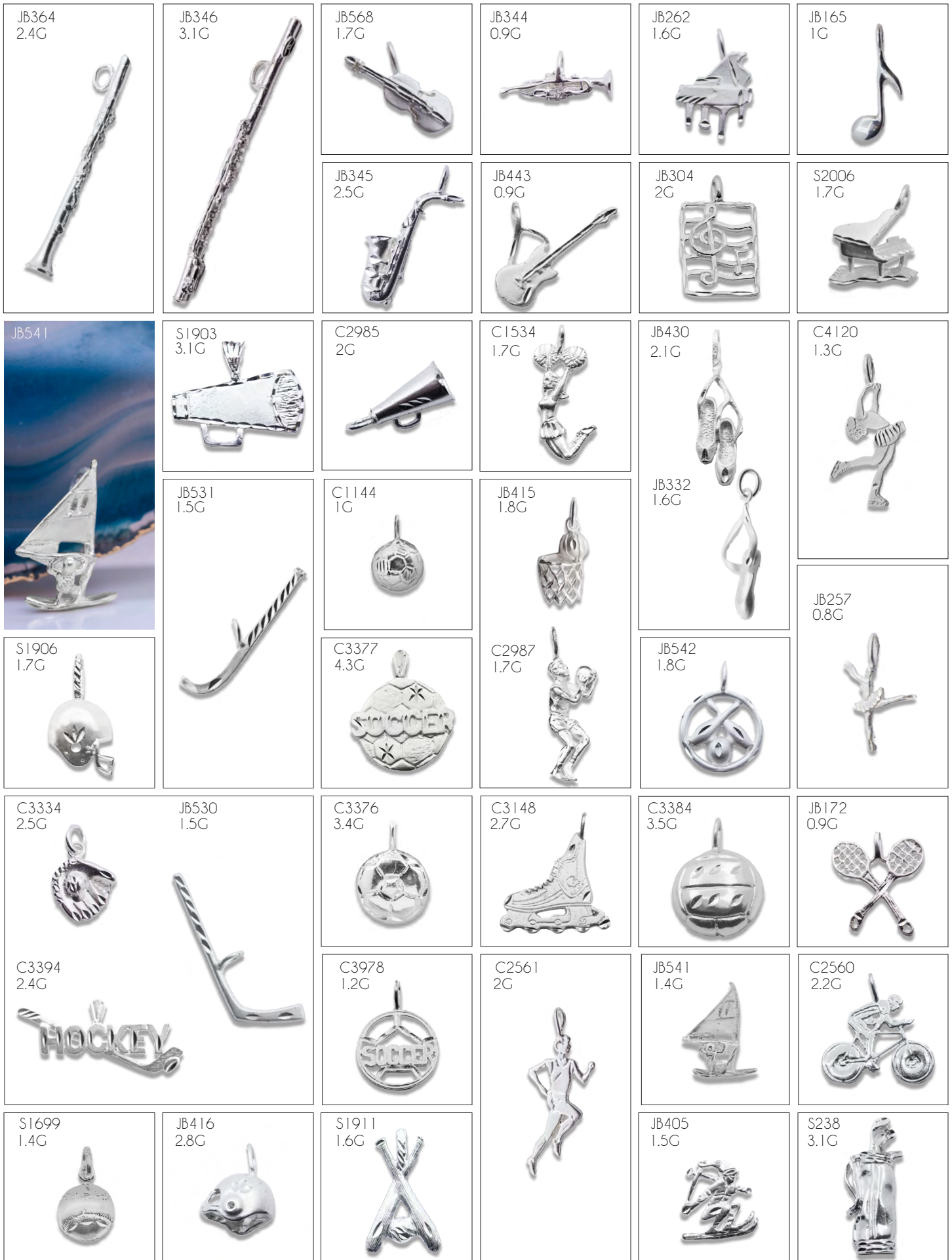































C4672
1.5G



JB583



C2965 2.5G 	C4051 3.1G 	C4050 2.8G 	S1460 1G 	S1239 1.4G 	JB466 1.6G 
	C3743 1.3G 	C4395 4.6G 	JB343 2.1G 	JB276 8.1G 	JB426 2.9G 
JB553 2.1G 	JB527 1.1G 	C4432 1.9G 	JB712 6.7G 		C1080 2.4G 
C2418 2.2G 	JB269 3G 	JB667 1.6G 	JB263 10.4G 	JB677 1.7G 	C3349 1.8G 
JB382 1.7G 	JB679 2G 	JB291 1.8G 	JB424 2.1G 	JB106 1G 	JB502 1.2G 
JB567 1.9G 	JB566 3.1G 	JB575 2.9G 	JB272 1G 	JB1055 1.1G 	JB103 2.8G 
	JB244 3.3G 	JB495 2G 	C4636 3.4G 	JB202 2.7G 	C4751 1.6G 
	JB602 1.8G 	JB163 1.4G 	JB333 2.4G 	C4437 3.4G 	C4746 3G 



C4369



CH4
1.3G



CH2
1.5G



CH2



S1769 1.4G
S1770 1.3G



JB491
1.6G



C1269
3.8G



C3982
1.1G



C3109
1.1G



JB548
1.6G



C4535P
3.18G



JB545
1.6G



JB175
1.8G



C4421
2.1G



JB579
2.8G



C4626
2.9G



C4822P
2.3G



JB120
1.9G



JB123
1.8G



JB306
1.1G



JB139
1G



JB492
1.7G

C4370
1.9G



S1392
1.6G



JB564
1.7G



JB229
1.4G



C4217
1.5G



C4396
2.1G



C4369
3.5G



C4705P
1.8G



JB619
2.1G



C4714P
4.1G



JB266
2.8G



JB270
1.1G



C3368
1.4G



JB334
1.1G



JB335
1.8G



JB336
3.8G



JB392
1.1G



C3780
1.8G



JB143
1.1G

C4578P



C4752
2.9G



JB369
3G



C1190
2G



JB440
2G



C4578P
2.7G



A5084
1G



C4748P
2.3G



JB242
1.8G



C4749
2.1G



C4666
1.5G



JB555
1.7G



C1189
5.4G



C1535P
1.7G



JB363
1.1G



C4631
3.4G



C4129
4.3G



JB520
1G



A5081
0.6G



A5092
0.5G



JB363

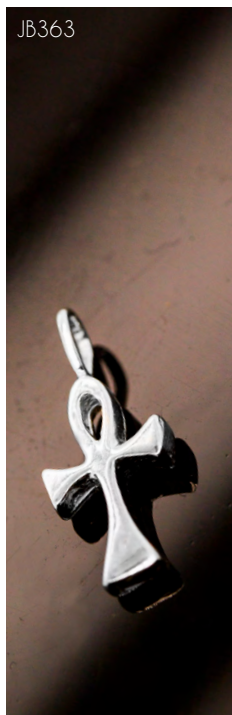

C4754
2.2G



C4744
1.5G



C3674
3.8G



C4757
2.5G



C3108
0.8G



C4753
2.2G



A5089
1G



C4745
1.8G

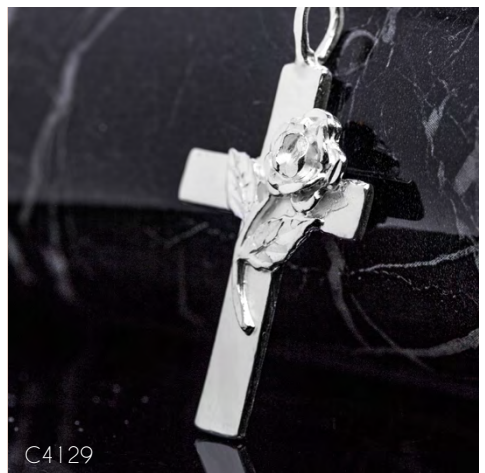

C4129

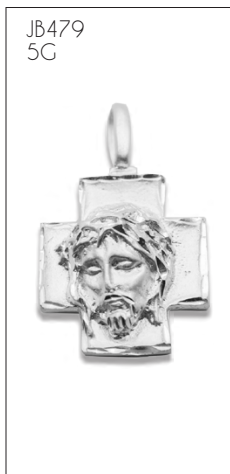
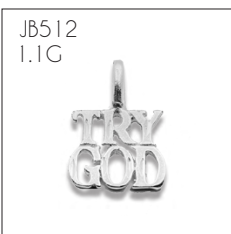
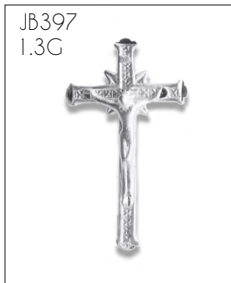



THEMED COLLECTIONS

CANADIAN COLLECTION P. 77

CHRISTMAS + SNOWFLAKE COLLECTION P. 78

BIRTHSTONE COLLECTION P. 79 - 80

OWL COLLECTION P. 81

TORONTO COLLECTION P. 81

MORGANITE COLLECTION P. 81

TREE OF LIFE COLLECTION P. 82

FAMILY COLLECTION P. 83

NAUTICAL COLLECTION P. 83

HELLO KITTY INSPIRED COLLECTION P. 83

ALPHABET COLLECTION P. 84 - 85

SIMULATED OPAL COLLECTION P. 86

INFINITY COLLECTION P. 87

NATURAL STONE COLLECTION P. 88

VAN CLEEF INSPIRED COLLECTION P. 89

TIFFANY INSPIRED COLLECTION P. 90 - 91

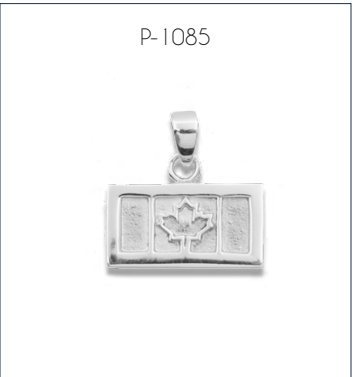
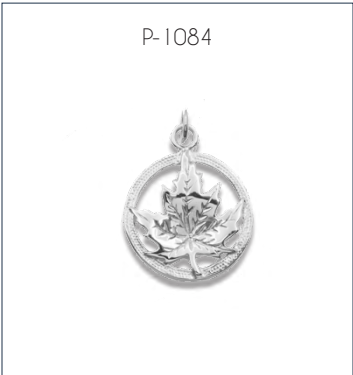
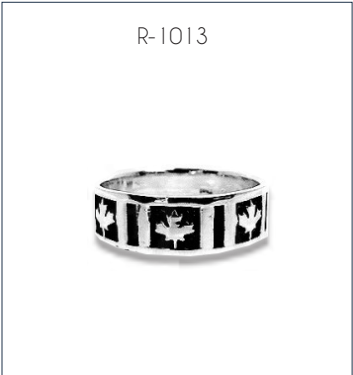
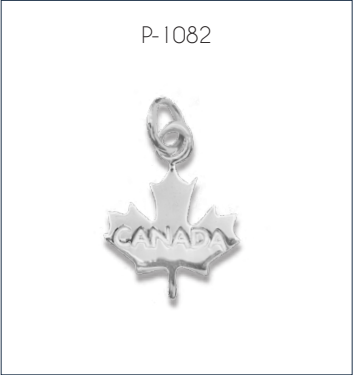



ST-1370



ST-1177



ST-1449

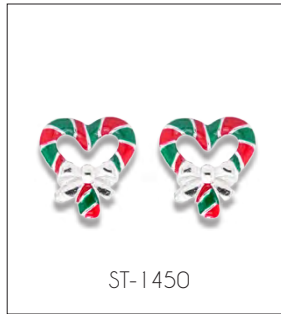

ST-1450



ST-1276



ST-1370-G



ST-1275



ST-1277



ST-1511



ST-1274



ST-1514



N-1160



ST-1172



ST-1297



ST-1258



N-1395



ED11078



ST-1297
ST-1277
ST-1511



P-1127



C4705P



ER-1308



P-1383



P-1274-R

PENDANT SIZE: 4MMX6MM GENUINE BIRTHSTONE COLLECTION STUDS SIZE: 4MMX6MM



JANUARY - GARNET
P-1411-JAN
PS-1054-JAN
ST-1339-JAN



FEBRUARY - AMETHYST
P-1411-FEB
PS-1054-FEB
ST-1339-FEB



MARCH - ACQUAMARINE
P-1411-MAR
PS-1054-MAR
ST-1339-MAR



APRIL - WHITE TOPAZ
P-1411-APR
PS-1054-APR
ST-1339-APR



MAY - EMERALD
P-1411-MAY
PS-1054-MAY
ST-1339-MAY



JUNE - MOONSTONE
P-1411-JUN
PS-1054-JUN
ST-1339-JUN



P-1418-AUG



JULY - RUBY
P-1411-JUL
PS-1054-JUL
ST-1339-JUL



AUGUST - PERIDOT
P-1411-AUG
PS-1054-AUG
ST-1339-AUG



SEPTEMBER - SAPPHIRE
P-1411-SEP
PS-1054-SEP
ST-1339-SEP



OCTOBER-OPAL
P-1411-OCT
PS-1054-OCT
ST-1339-OCT



NOVEMBER- CITRINE
P-1411-NOV
PS-1054-NOV
ST-1339-NOV



DECEMBER- BLUE TOPAZ
P-1411-DEC
PS-1054-DEC
ST-1339-DEC

SIMULATED BIRTHSTONE STUDS
5MM



ST-1024-JAN GARNET
ST-1024-FEB AMETHYST
ST-1024-MAR AQUAMARINE
ST-1024-APR DIAMOND
ST-1024-MAY EMERALD
ST-1024-JUN ALEXANDRITE
ST-1024-JUL RUBY
ST-1024-AUG PERIDOT
ST-1024-SEP SAPPHIRE
ST-1024-OCT PINK TOURMALINE
ST-1024-NOV CITRINE
ST-1024-DEC TANZANITE

SIMULATED BIRTHSTONE PENDANTS
18MMX10MM



P-1418-JAN GARNET
P-1418-FEB AMETHYST
P-1418-MAR AQUAMARINE
P-1418-APR DIAMOND
P-1418-MAY EMERALD
P-1418-JUN ALEXANDRITE
P-1418-JUL RUBY
P-1418-AUG PERIDOT
P-1418-SEP SAPPHIRE
P-1418-OCT PINK TOURMALINE
P-1418-NOV CITRINE
P-1418-DEC BLUE ZIRCON

BIRTHSTONE COLLECTION

CUSTOMERS WHO BUY A COMPLETE BIRTHSTONE COLLECTION WILL RECEIVE A FREE DISPLAY. PLEASE CALL US AT 1 (800) 668 - 4422 FOR DETAILS.

SIMULATED BIRTHSTONE STUDS
9MM



ST-1425-R
GARNET-JAN



ST-1425-A
AMETHYST-FEB



ST-1425-AQ
AQUAMARINE-MAR



ST-1425-CZ
DIAMOND-APR



ST-1425-E
EMERALD-MAY



ST-1425-AL
ALEXANDRITE-JUN



ST-1425-G
RUBY-JUL



ST-1425-P
PERIDOT-AUG



ST-1425-S
SAPPHIRE-SEP



ST-1425-T
TANZANITE-OCT



ST-1425-C
CITRINE-NOV



ST-1425-TQ
TURQUOISE-DEC



ST-1425-T

SIMULATED BIRTHSTONE PENDANTS
13MMX15MM



P-1368-JAN
GARNET



P-1368-FEB
AMETHYST



P-1368-MAR
AQUAMARINE



P-1368-APR
DIAMOND



P-1368-MAY
EMERALD



P-1368-JUN
ALEXANDRITE



P-1368-JUL
RUBY



P-1368-AUG
PERIDOT



P-1368-SEP
SAPPHIRE



P-1368-OCT
TOURMALINE



P-1368-NOV
CITRINE



P-1368-DEC
BLUE ZIRCON

P-1368-OCT
P-1368-JUL
P-1368-FEB





ST-1211



ER-1213



P-1308



ER-1212



P-1057

MOVEABLE

OWL COLLECTION



ST-1253-R



N-1247-R



N-1248



ST-1252-R



ST-1253

TORONTO COLLECTION*



R-1358-RG



BR-1350

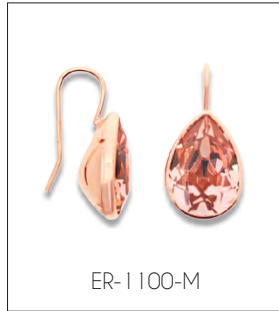

ER-1100-M



ER-1100-S



ER-1298-R

MORGANITE COLLECTION

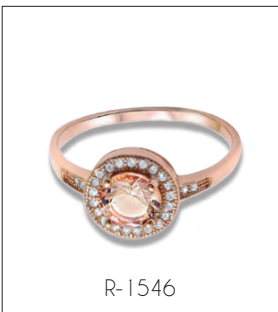

R-1546



BR-1349

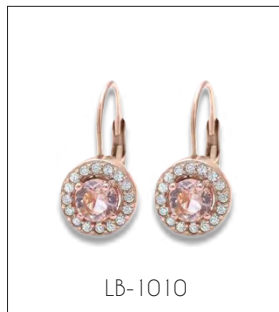

LB-1010



ST-1058-R-MC



R-1358-RG

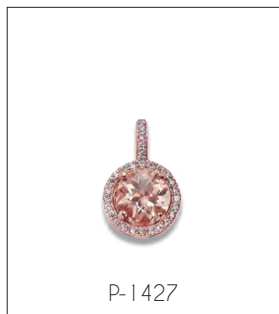

P-1427



R-1546

ALL MORGANITE JEWELLERY IS SIMULATED UNLESS STATED OTHERWISE. TO SEE OUR ENTIRE MORGANITE COLLECTION PLEASE VISIT OUR WEBSITE. CITY NECKLACES CAN BE MADE ON A SPECIAL ORDER BASIS. MOQs APPLY.



LOC-OE-1079



R-1551



R-1206



ER-1066



PIN-100



ST-1219



R-1198



ST-1220



ER-1092



ER-1063



ER-1064



P-1231



ER-1109



P-1096



P-1349



P-1350



P-1097

27MM

P-1098

33MM

P-1100



ER-1062



ER-1231

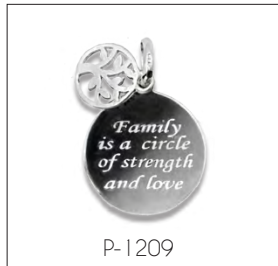

P-1209



P-1099



ER-1309

ER-1092



P-1234



P-1194

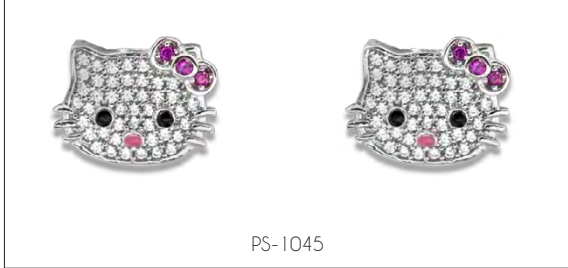
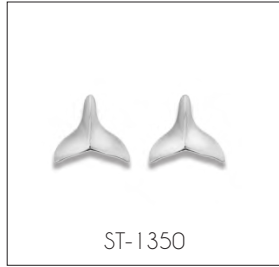
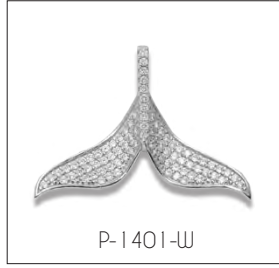
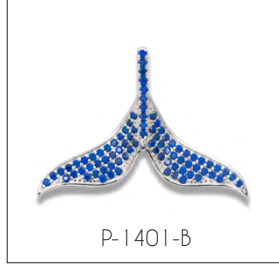

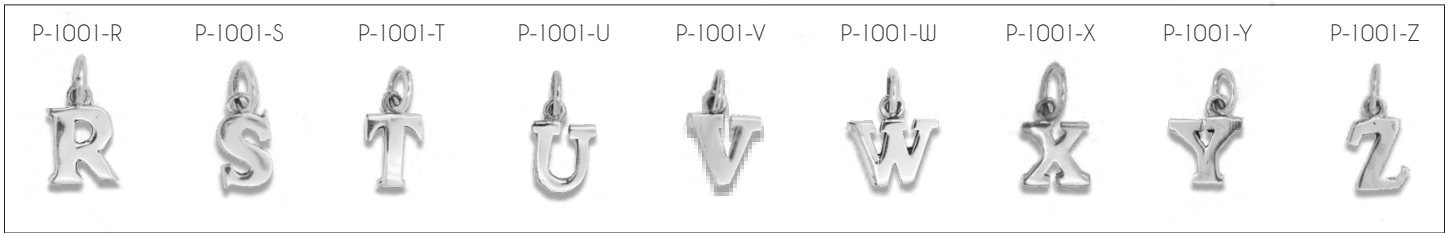

P-1001-H
P-1001-G
P-1001-E
P-1001-B

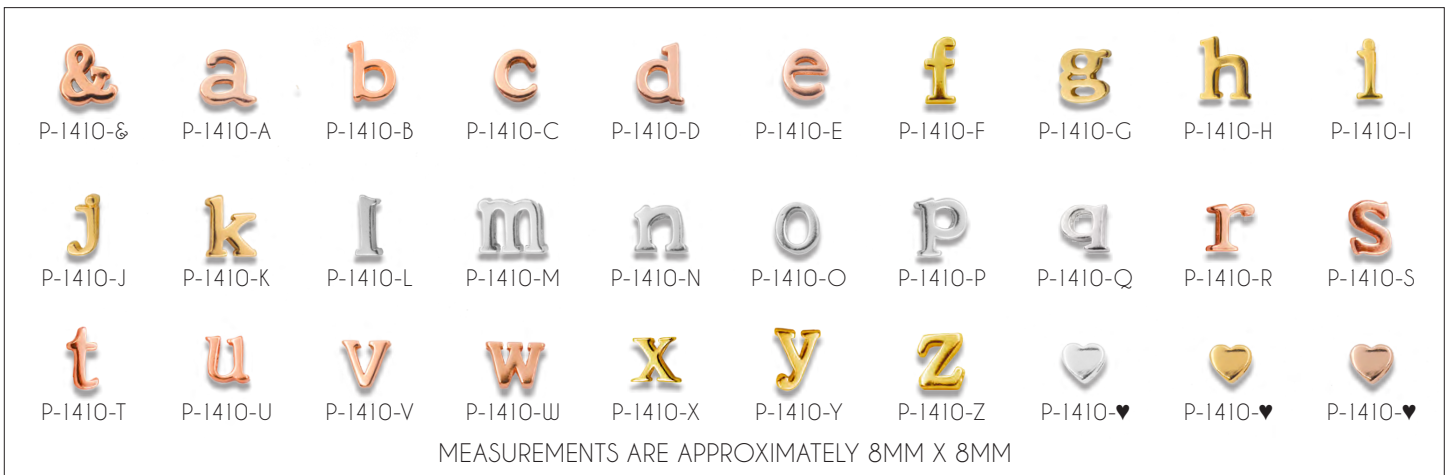



ST-1313

AA

ST-1313-A

BB

ST-1313-B

CC

ST-1313-C

DD

ST-1313-D

EE

ST-1313-E

FF

ST-1313-F

GG

ST-1313-G

HH

ST-1313-H

II

ST-1313-I

JJ

ST-1313-J

KK

ST-1313-K

LL

ST-1313-L

MM

ST-1313-M

NN

ST-1313-N

OO

ST-1313-O

PP

ST-1313-P

QQ

ST-1313-Q

RR

ST-1313-R

SS

ST-1313-S

TT

ST-1313-T

UU

ST-1313-U

VV

ST-1313-V

WW

ST-1313-W

XX

ST-1313-X

YY

ST-1313-Y

ZZ

ST-1313-Z

6MM X 6MM



N-1255-E
N-1255-A
N-1255-D

N-1255-H
N-1255-I
N-1255-N

N-1255-M
N-1255-K
N-1255-R

N-1255-L
N-1255-S
N-1255-T

9.5MM

N-1255-I
N-1255-F



ALL OUR ALPHABET JEWELLERY IS AVAILABLE IN A - Z. ALL P-1410 PENDANTS ARE AVAILABLE IN RHODIUM, GOLD, AND ROSE GOLD OPTIONS.





ST-1066



ST-1066-C



ST-1066-R



ST-1060



ST-1060-C



ST-1060-R



N-1029-R
N-1029-C
N-1029



N-1105-R
N-1105-C
N-1105



N-1025-R
N-1025-C
N-1025

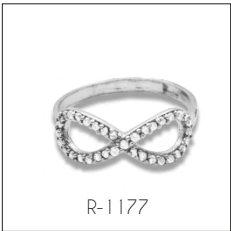

R-1177



R-1177-C



R-1177-R

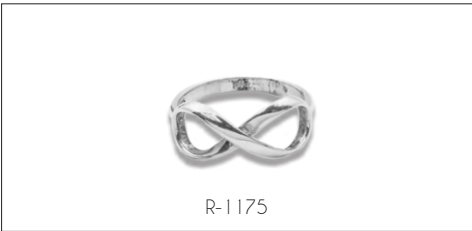

R-1175



DOUBLE-SIDED

R-1552



BR-1109



BR-1216



BR-1066



P-1193



P-1276



ST-1396



ST-1396-C



ST-1396-R



BR-1109
BR-1109-C
BR-1109-R



P-1455

MOTHER OF PEARL



ST-1229-MP

BLACK ONYX



ST-1229-BO

TURQUOISE



ST-1229-G-T

TURQUOISE
MOTHER OF PEARL
BLACK ONYX



N-1208-MP
N-1208-BO
N-1208-G-T

BLACK ONYX
TURQUOISE
ROSE QUARTZ



N-1213-BO
N-1213-GT
N-1213-R-Q

BLACK ONYX



ST-1309

TURQUOISE



ST-1309-G

ROSE QUARTZ



ST-1309-R

MOON STONE



ER-1283-MS

ROSE QUARTZ



ER-1283-R

LABRADORITE



ER-1283-LAB

MOON STONE
ROSE QUARTZ
LABRADORITE



N-1295-MS
N-1295-RQ
N-1295-LAB

TURQUOISE
ROSE QUARTZ
MOTHER OF PEARL
BLACK ONYX



N-1206-G-T
N-1206-RQ
N-1206-MP
N-1206-BO

TURQUOISE



ST-1377-TQ

ROSE QUARTZ



ST-1377-RQ

BLACK ONYX



ST-1377-BO

IB-1094-G



TURQUOISE
N-1354



LABRADORITE



IB-1094-G

TURQUOISE



ST-1227-G-TQ

CORAL



ST-1227-G-C



BR-1126-W
BR-1126-W-R
BR-1126-W-G



BR-1126-B
BR-1126-B-R
BR-1126-B-G



N-1040
N-1040-R
N-1040-G

N-1041
N-1041-R
N-1041-G

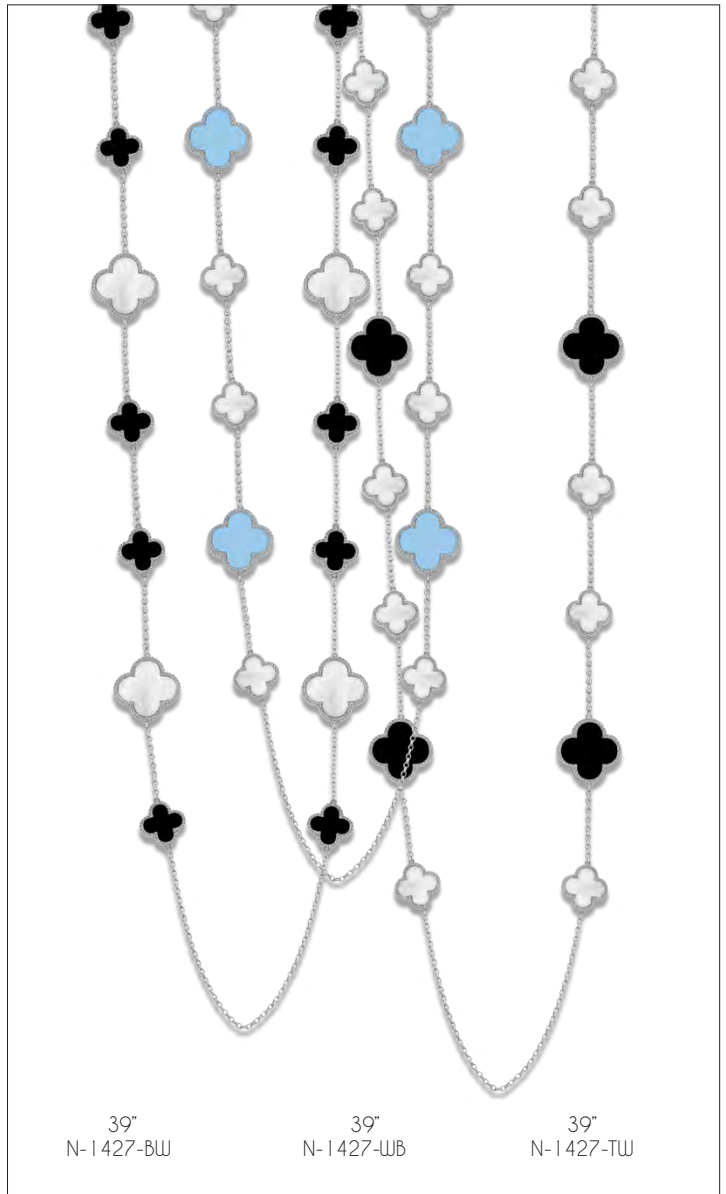

39"
N-1427-BW

39"
N-1427-WB

39"
N-1427-TW



36"

●● N-1031-W
●● N-1031-B
N-1226



ST-1452

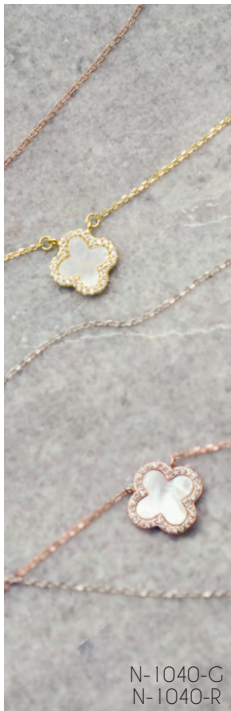

N-1040-C
N-1040-R



●● ST-1072

●● ST-1072-B



AVAILABLE IN 6.5+1", 9"+1", 16", 18", 20", 24", 36", 54" AND 98"

N-1007-R

N-1007-G

N-1007



AVAILABLE IN
7", 8" AND 18"
18" ~ 34G

TH-1



N-1366



IB-1045



AVAILABLE IN 7", 8", 16", 18" AN 20"

18" ~ 40G

TH-2



SB-1028



TH-7



AVAILABLE IN 7", 8", 16" AND 18"

18" ~ 35G

TH-7

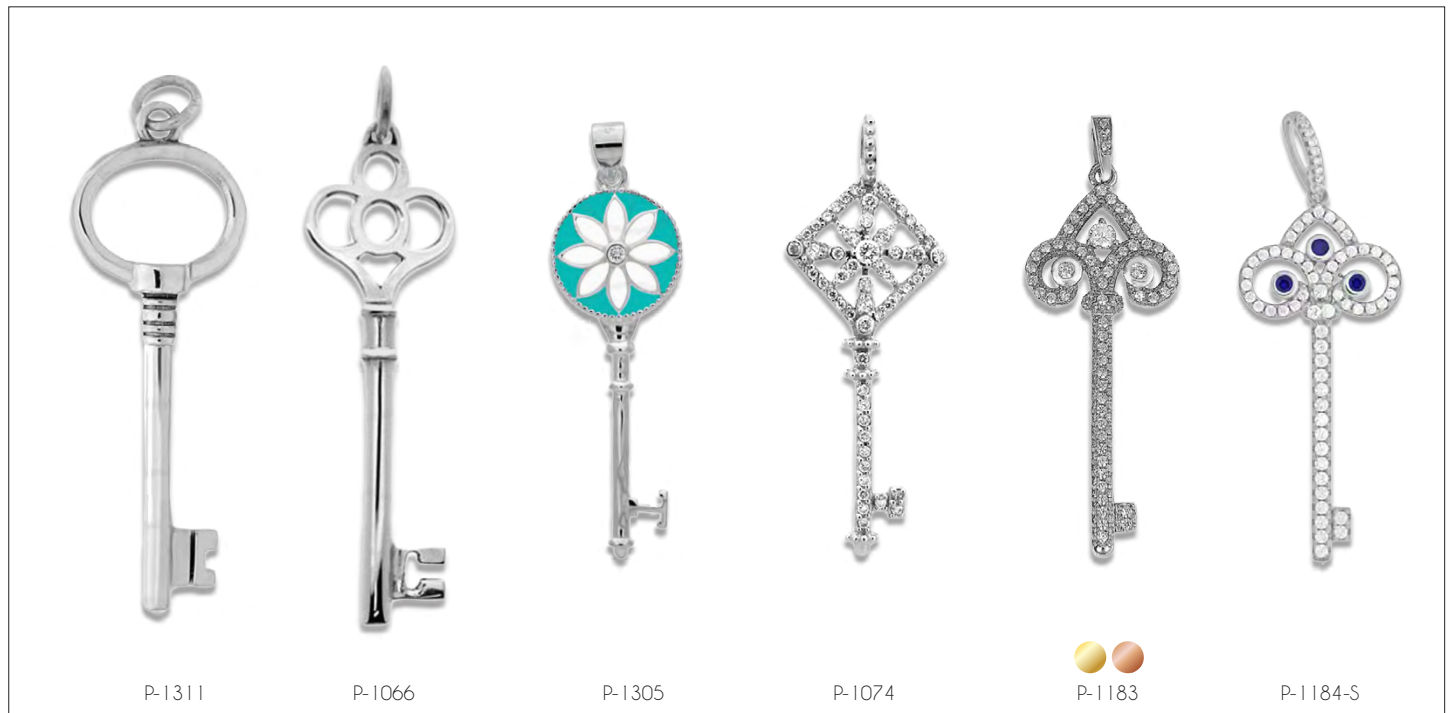
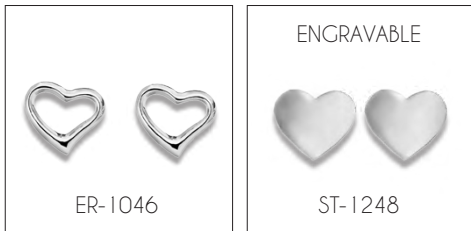



MEN'S JEWELLERY

MEN'S RINGS P. 93

CUFFLINKS P. 93

MEN'S STUDS P. 93

TIE BARS P. 93

MONEY CLIPS P. 93

HIP HOP JEWELLERY P. 94 - 95

RM-064
RM-007
RM-029-BO
RM-035



RM-066



RM-065



RM-064

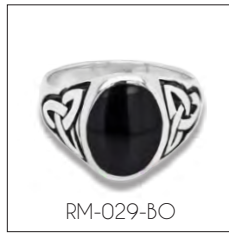

RM-029-BO



RM-007



RM-035

MEN'S RINGS



CL-100



CL-113



CL-107



CL-106



CL-104



CL-114

CUFFLINKS



CL-100
CL-113



ST-1235



ST-1235-B



ST-1236



ST-1334

LOOKING FOR MORE SCREWBACKS? VISIT PAGE 39 TO SEE MORE DESIGNS LIKE THIS!

MEN'S STUDS



MC-103



10MM X 50MM X 7.5MM

SATIN FINISH
MC-106



TB-104

TIE BARS



HAMMERED
MC-102



MC-100



10MM X 50MM X 8.5MM

MC-101



MC-100

MONEY CLIPS

N-1458
BULLET-300
N-1457



BULLET-300



5.9MM 24" 53.80G AVAILABLE IN 24", 30", AND 36"

HIP-HOP JEWELLERY



7.9MM 26" 75G
N-1458-G



8.1MM 26" 72G
N-1457



7.9MM 9" 28G

BR-CZ-142

BR-CZ-142-G



8.1MM 9" 26G

BR-CZ-143

BR-CZ-143-G



R-1565



R-1567



60MM X 40MM

P-1406

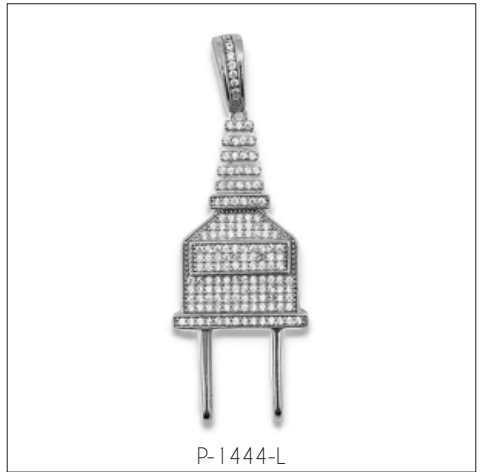

P-1444-L



P-1430



P-1431

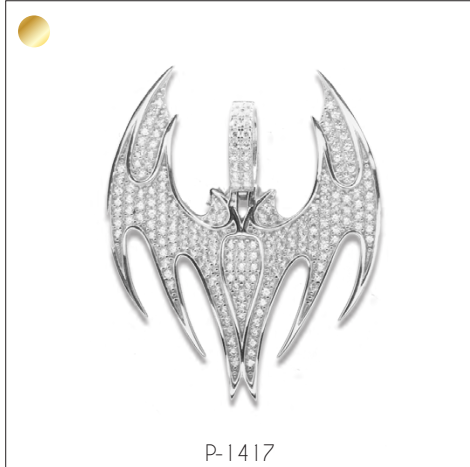

P-1417



P-1452



P-1384



P-1282



CR-1396

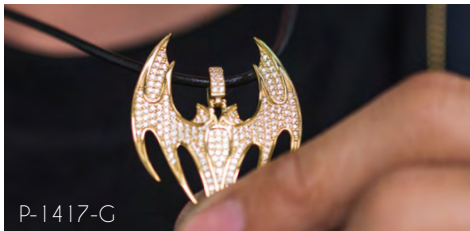

P-1417-G

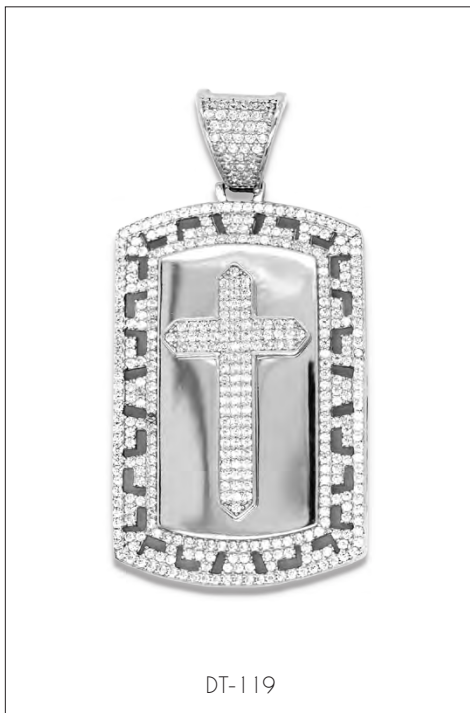

DT-119

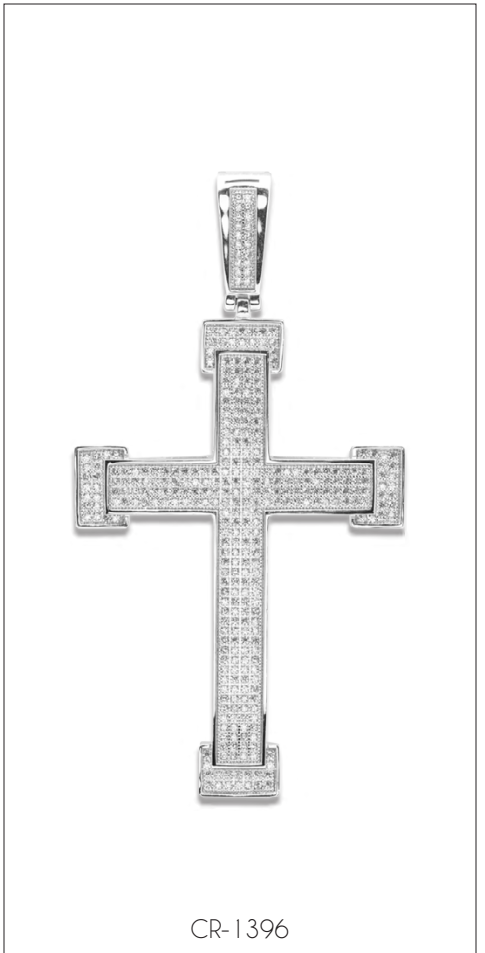

CR-1396



P-1453



BODY JEWELLERY

TOE RINGS P. 97

ANKLETS P. 98 - 99

NOSE PINGS P. 99

SEPTUM RINGS P. 99



TR-1001

TR-1002

TR-1004

TR-1005

TR-1007

TR-1008

TR-1005
TR-1016



TR-1010

TR-1012

TR-1014

TR-1009

TR-1009-AQ



TR-1015

TR-1016

TR-1018

TR-1009-E

TR-1009-P



TR-1020

TR-1021

TR-1022

TR-1009-LS

TR-1009-S



TR-1023

TR-1024

TR-1025

TR-1027

TR-1009-A

TR-1009-G



TR-1030
TR-1025

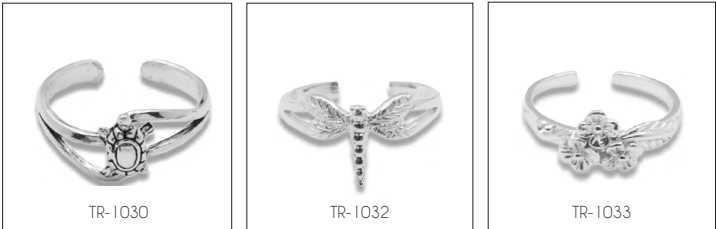

TR-1030

TR-1032

TR-1033



TR-1035

TR-1037

TR-1038

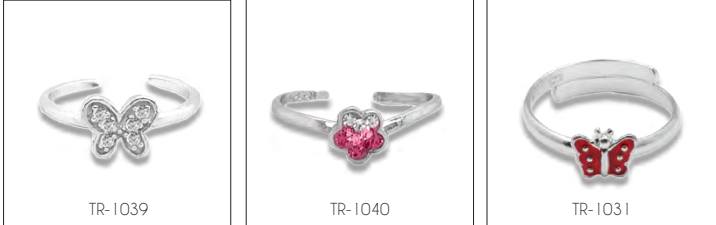

TR-1039

TR-1040

TR-1031

ALL TOE RINGS ARE ADJUSTABLE. TOE RING DISPLAYS ARE AVAILABLE FOR PURCHASE. PLEASE CONTACT US FOR MORE INFORMATION.

	ANK-1001
1.5MM	
	ANK-1003
1.5MM	
	ANK-1004
1.2MM	
	ANK-1005
1.9MM	
	ANK-1007
6MM	
	ANK-1009
2.2MM	
	ANK-1012
2MM	
	ANK-1024
	ANK-1026
	ANK-1027
	ANK-1028
	ANK-1030
	ANK-1056
0.7MM	
	ANK-1058

	ANK-1077
	ANK-1080
2.8MM	
	ANK-1081
1.4MM	
	ANK-1082
1.7MM	
	ANK-1083
2.3MM	
	ANK-1084
3.5MM	
	ANK-1084-G
3.5MM	
	ANK-1088
1.2MM- BALL : 2.3MM	
	ANK-1089-G
4.3MM	
	ANK-1090
5.2MM	
	ANK-1091
3.2MM	
	ANK-1093
	ANK-1094
	ANK-1095



 ANK-1054-G

 ANK-1055

 ANK-1068-G

 ANK-1069-G

 ANK-1070

 ANK-1071-G

 ANK-1073-G

ANK-1078

 ANK-1092-G

ANKLETS



NRB-1005-C



NRB-1003
NRB-1013
NRB-1005

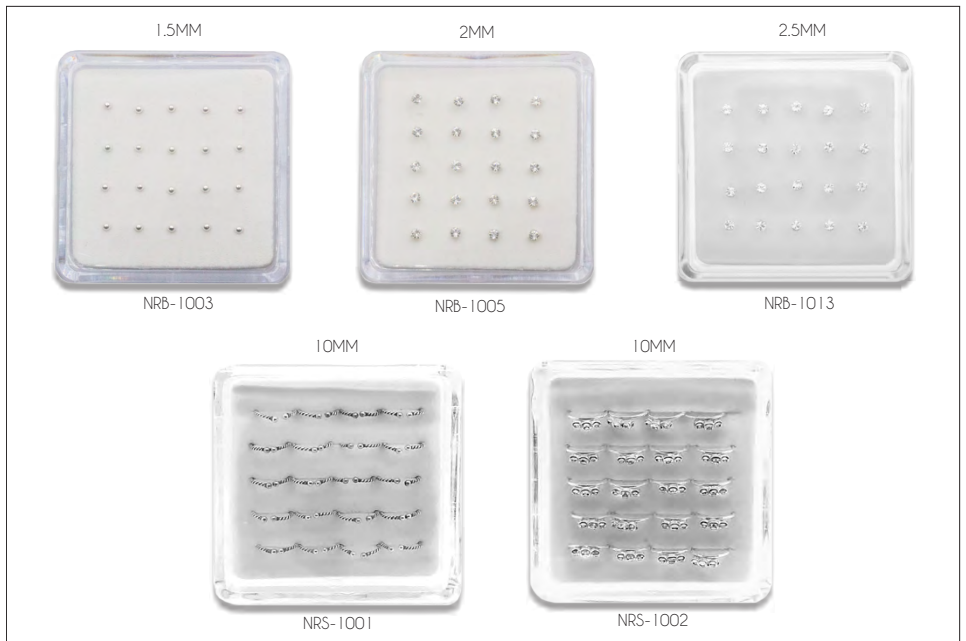

NOSE PINS

SEPTUM RINGS

FINDINGS

- ITALIAN SEAMLESS BEADS P. 101
- JUMP RINGS P. 101
- SPLIT RINGS P. 101
- SPRING RINGS P. 101
- PEAR LOBSTER CLASPS P. 101
- FIGURE 8 CLASPS P. 101
- RECTANGULAR LOBSTER CLASPS P. 102
- SCREW CLASPS P. 102
- “S” CLASP P. 102
- FISH HOOK CLASP P. 102
- MAGNETIC CLASPS P. 102
- BACKINGS P. 102
- LEATHER CORD P. 102
- CRIMP P. 102
- FISH HOOKS + LEVERBACKS P. 102
- EXTENDERS P. 102
- LOOSE ALHAMBRA P. 102
- 10K + 14K LOBSTER CLASPS P. 103
- 10K + 14K STUD BUTTERFLIES P. 103
- 10K + 14K SILICONE BUTTERFLIES P. 103
- 10K + 14K EXTENDERS P. 103
- 10K + 14K JUMP RINGS P. 103
- 10K + 14K SPRING RINGS P. 103

*HIGH POLISHED

2MM IB-2 0.022G	3MM IB-3 0.043G	4MM IB-4 0.077G	5MM IB-5 0.137G	6MM IB-6 0.23G	7MM IB-7 0.35G	8MM IB-8 0.5G

*SAND BLASTED

2MM BD-SB-2 0.09G	3MM BD-SB-3 0.18G	4MM BD-SB-4 0.61G	5MM BD-SB-5 1.30G

*HIGH POLISHED

4MM IB-4-G 0.05G	5MM IB-5-G 0.12G	8MM IB-8-G 0.40G	10MM IB-10-G 0.9G



4MM JR-4 0.076G	5MM JR-5 0.102G	6MM JR-6 0.127G	7MM JR-7 0.155G	8MM JR-8 1.180G

5MM SR-5 0.9G	6MM SR-6 0.14G	7MM SR-7 0.22G	8MM SR-8 1.18G

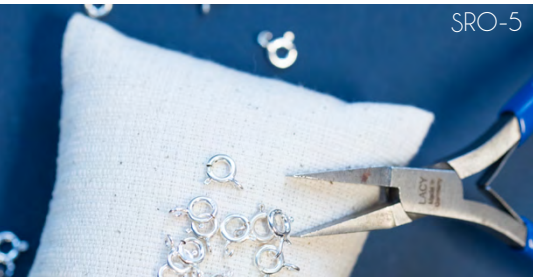

5MM SRO-5 0.16G	5.5MM SRO-5.5 0.18G	6MM SRO-6 0.20G	7MM SRO-7 0.22G	8MM SRO-8 0.30G

5X9MM 	6X10MM 	7X12MM 	8X14MM
PC-1 0.28G	PC-2 0.5G	PC-3 0.8G	PC-4 1.2G

6X10MM
PC-2-G 0.6G

6X10MM
PC-2-R 0.6G

6X10MM
PC-2-RH 0.6G

6X10MM
PC-2-B 0.6G

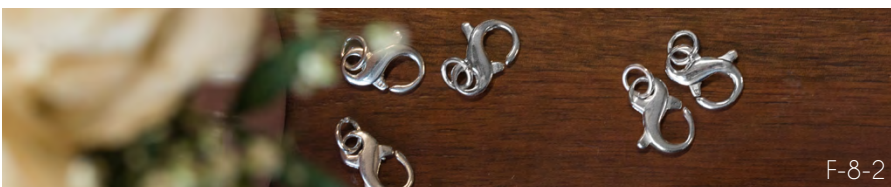

	F-8-1 1.80G 9X15MM		F-8-2 2.40G 12X20MM
--	--------------------------	--	---------------------------

ITALIAN SEAMLESS BEADS

JUMP RINGS







SPLIT RINGS

SPRING RINGS





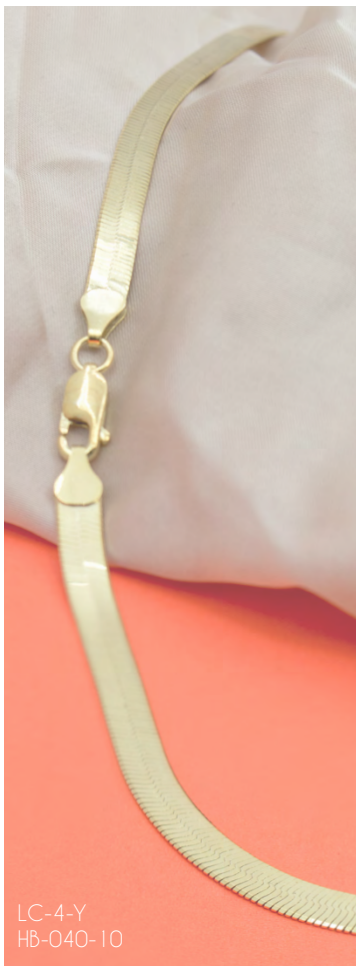

PEARL LOBSTER CLASPS

FIGURE 8 CLASPS

RECTANGULAR LOBSTER CLASPS	3X8MM LC-0 0.27G	4X10MM LC-1 0.40G	5X12MM LC-2 0.6G	6X14MM LC-3 0.80G	6X16MM LC-4 1.4G	8X16MM LC-5 2G	9X18MM LC-6 2.8G	4X11MM LC-1-G 0.35G	5X13MM LC-2-G 0.62G		
SCREW CLASPS	 221S-G 14.5MM	"S" CLASP 9X9MM 605S 0.4G	FISH HOOK CLASP 10MM FHC-S 0.224G	MAGNETIC CLASP 450S 6X10MM 452S 5X13MM							
BACKINGS	4X3.5MM CL-S 0.03G	4X4.5MM CL-L 0.06G	LEATHER CORD 2MM LC-2-B AVAILABLE IN 16", 18" & 20	CRIMP 3X6MM BA-14 0.04G							
FISH HOOKS & LEVER BACKS	 EW-1	16X10MM LVB-1 0.08G	20MM EW-3 0.18G	17MM EW-2 0.16G	24MM EW-1 0.31G						
EXTENDERS	 EX-2-RH EX-2 EX-R-1 EX-1-G	1" EX-1 0.28G	1" EX-1-G 0.28G	1" EX-1-R 0.28G	2" EX-2 0.475G	2" EX-2-G 0.475G	2" EX-2-R 0.475G				
LOOSE ALHAMBRA	VCF-2-B BLACK ONYX VCF-2-MP MOTHER OF PEARL 14.6MM X 14.6MM X 1.8MM VCF-2 VCF-2-T COMPOSITE TURQUOISE VCF-2-M COMPOSITE MALACHITE ALHAMBRA ARE SOLD IN PACKS OF 10	VCF-1-B BLACK ONYX VCF-1-MP MOTHER OF PEARL 8.3MM X 8.3MM X 2MM VCF-1 COMPOSITE TURQUOISE VCF-1-T COMPOSITE MALACHITE VCF-1-M ALHAMBRA ARE SOLD IN PACKS OF 10									

	LC-0-W	10K 0.3G 14K 0.32G 7.1MM X 2.7MM
	LC-1-W	10K 0.46G 14K 0.55G 9.7MM X 3.8MM
	LC-2-W	10K 0.66G 14K 0.74G 11.6MM X 4.3MM
	LC-3-W	10K 0.98G 14K 1.16G 13.6MM X 5.2MM
	LC-4-W	10K 1.6G 14K 1.83G 16MM X 6.2MM
	LC-6-W	10K 1.84G 14K 2.11G 15.3MM X 7.2MM
	LC-8-W	10K 2.98G 14K 3.48G 18.1MM X 9MM





	LC-0-Y	10K 0.3G 14K 0.32G 7.1MM X 2.7MM
	LC-1-Y	10K 0.46G 14K 0.55G 9.7MM X 3.8MM
	LC-2-Y	10K 0.66G 14K 0.74G 11.6MM X 4.3MM
	LC-3-Y	10K 0.98G 14K 1.16G 13.6MM X 5.2MM
	LC-4-Y	10K 1.6G 14K 1.83G 16MM X 6.2MM
	LC-6-Y	10K 1.84G 14K 2.11G 15.3MM X 7.2MM
	LC-8-Y	10K 2.98G 14K 3.48G 18.1MM X 9MM

5X5MM	5X5MM
	
CL-YS-10K CL-YS-14K	CL-WS-10K CL-WS-14K

10K & 14K SILICONE BUTTERFLIES





3X3MM	3X4MM	3X3MM	3X4MM
			
CL-S-Y-10K CL-S-Y-14K	CL-L-Y-10K CL-L-Y-14K	CL-S-W-10K CL-S-W-14K	CL-L-W-10K CL-L-W-14K

10K & 14K STUD BUTTERFLIES

	EX-2-Y-10K	2"	EX-2-Y-14K	2"
	EX-2-W-10K	2"	EX-2-W-14K	2"

10K & 14K STUD EXTENDERS



0.8MMX2MM	0.9MMX2.3MM	1MMX2.6MM	1MMX3MM	1.2MMX3.6MM
				
JR-0-Y 10K 0.04G 14K 0.05G	JR-Y-1 10K 0.07G 14K 0.08G	JR-Y-2 10K 0.11G 14K 0.11G	JR-Y-3 10K 0.12G 14K 0.13G	JR-Y-4 10K 0.19G 14K 0.21G

10K & 14K JUMP RINGS

		
4.5MM SR-0-Y 10K 0.0554G 14K 0.062G	5MM SR-1-Y 10K 0.067G 14K 0.077G	6MM SR-2-Y 10K 0.178G 14K 0.203G

10K & 14K SPRING RINGS



10K & 14K GOLD JEWELLERY

- ITALIAN 14K GOLD CHAINS P. 105**
- ITALIAN 10K GOLD CHAINS P. 106**
- TRENDY 10K GOLD RINGS P. 106**
- TRENDY 10K GOLD NECKLACES P. 107**
- TRENDY 10K GOLD NECKLACES P. 108**
- TRENDY 10K GOLD BRACELETS P. 108**
- TRENDY 10K GOLD EARRINGS P. 109**
- 10K GOLD HUGGIES P. 109**
- 10K GOLD ENDLESS SLEEPERS P. 110**
- 10K GOLD BALL STUDS P. 110**
- 10K BASKET SET CZ STUDS P. 110**
- 10K GOLD LEVERBACKS P. 110**
- 10K GOLD CZ PENDANTS P. 110**
- 14K GOLD + DIAMOND STUDS P. 111**
- 14K GOLD + DIAMOND HUGGIES P. 111**
- 14K GOLD + DIAMOND RINGS P. 111**
- 14 GOLD + DIAMOND NECKLACES + BRACELETS P. 111**
- 14K DIAMOND NOSE RINGS P. 112**
- 14K GOLD BALL STUDS P. 112**
- 14K GOLD BALL LEVERBACKS P. 112**
- 14K GOLD BASKET CZ STUDS P. 112**
- 14K GOLD CZ LEVERBACKS P. 112**

WHITE GOLD

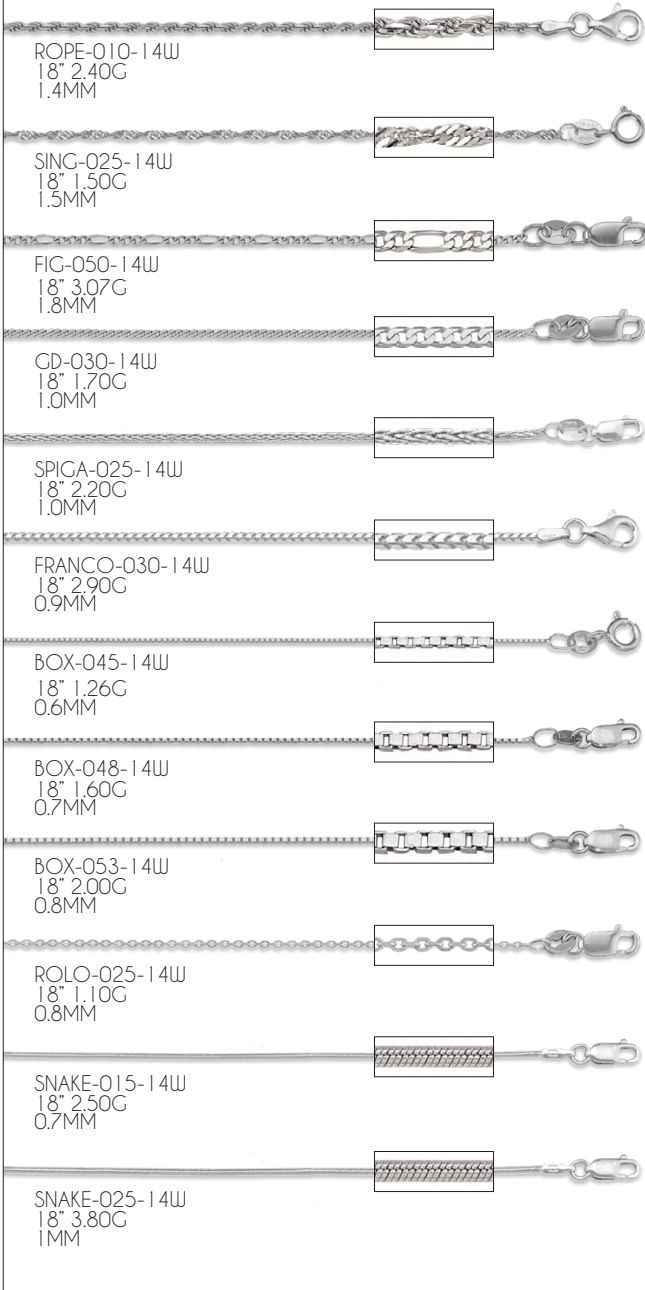

YELLOW GOLD

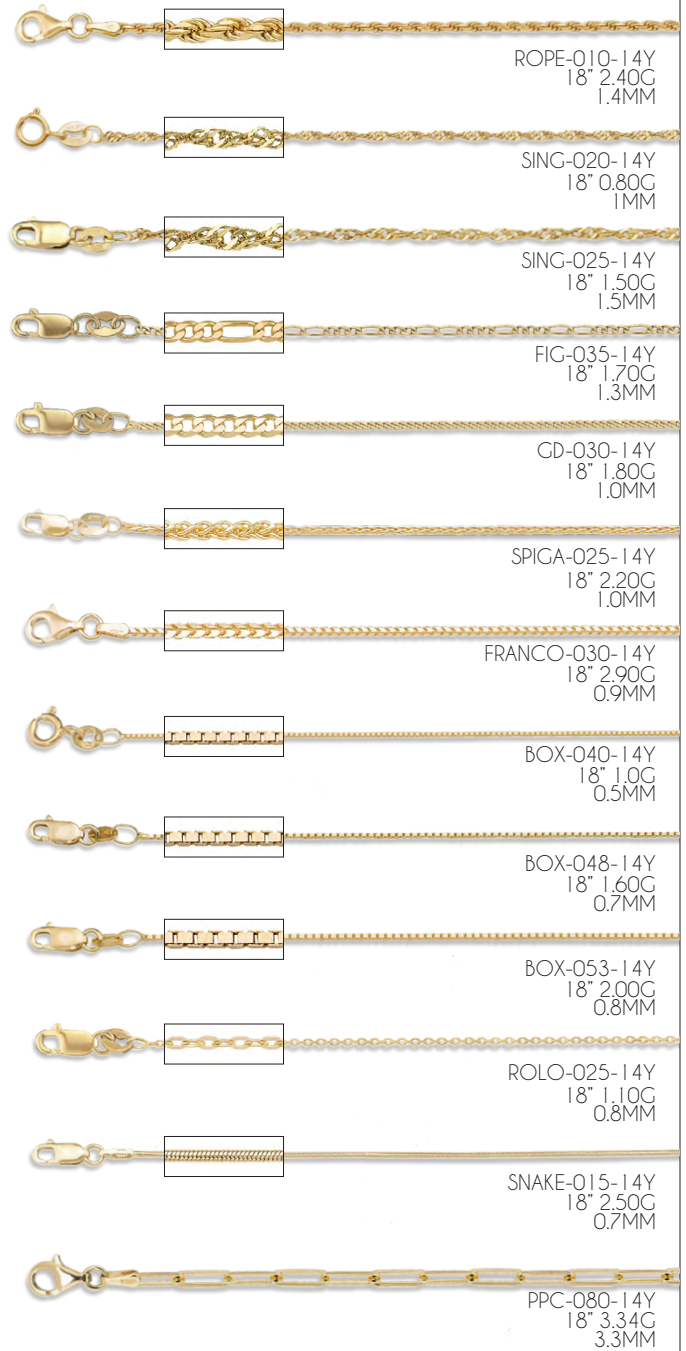

ROSE GOLD

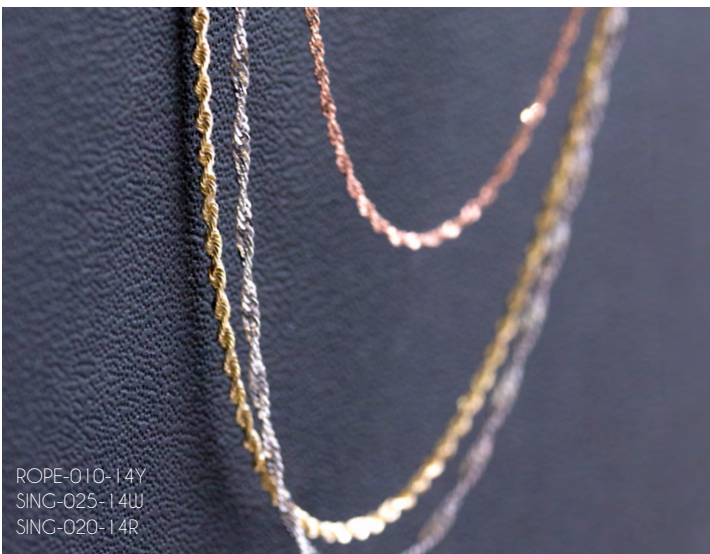
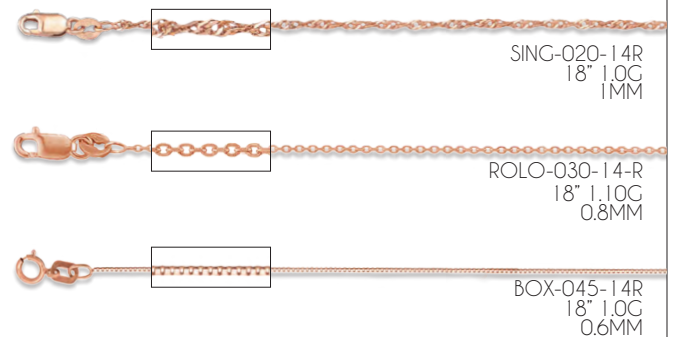
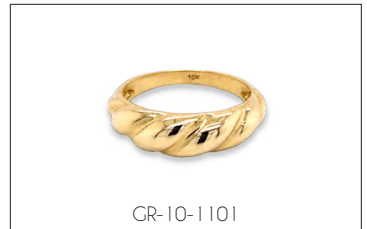
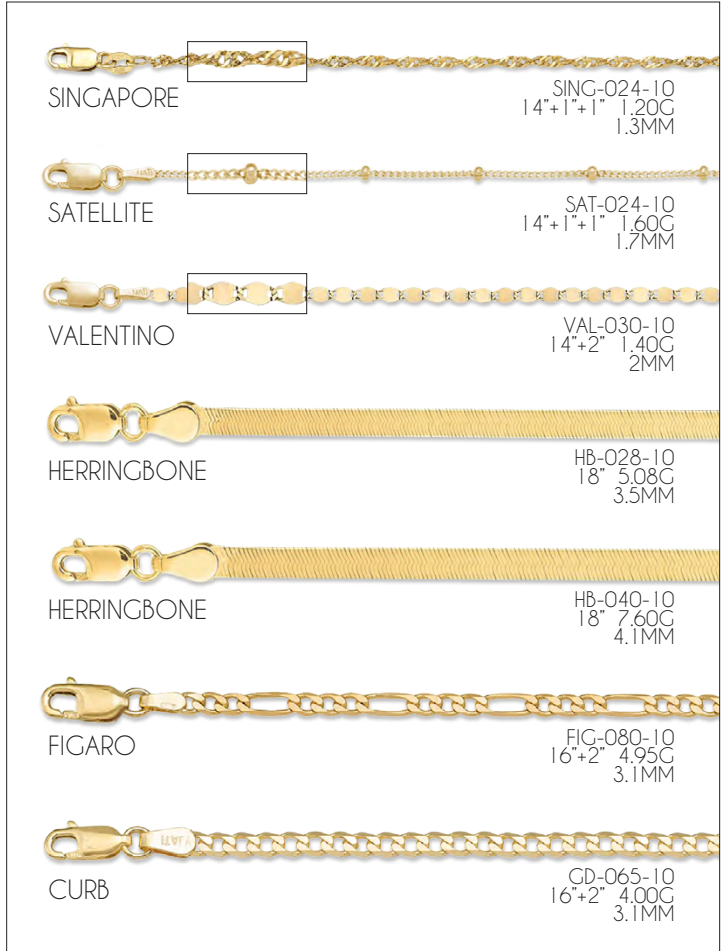



FIG-080-10
HB-040-10





TRENDY 10K GOLD NECKLACES



TRENDY 10K GOLD BRACELETS



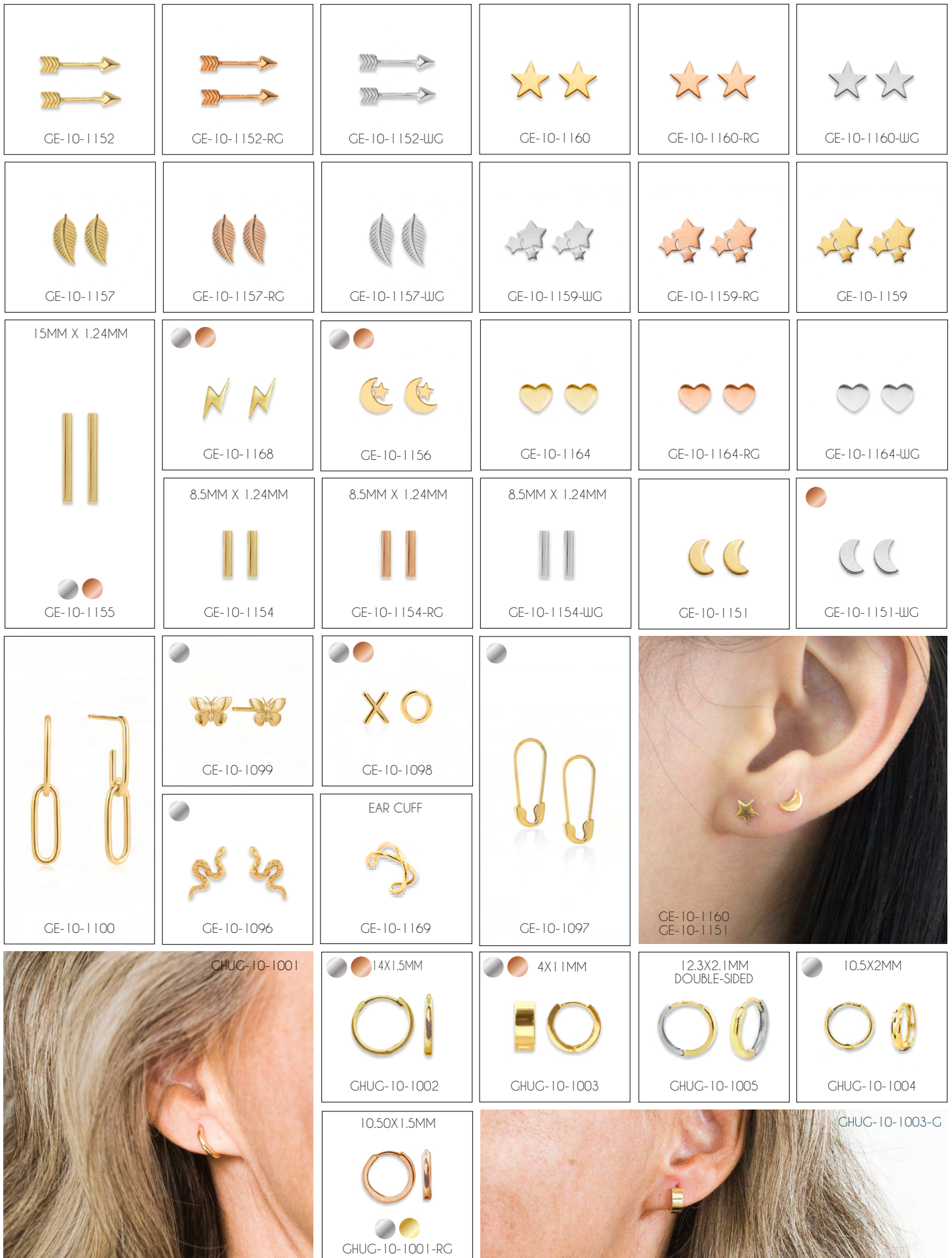





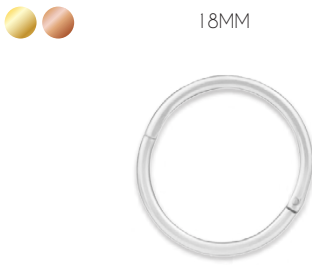

TRENDY 10K GOLD EARRINGS

10K GOLD HUGGIES

10K GOLD ENDLESS* SLEEPERS

 <p>10MM GSLP-10-G</p>	 <p>12MM GSLP-12-W</p>	 <p>18MM GSLP-18-W</p>	
 <p>14MM GSLP-14-R</p>	 <p>16MM GSLP-16-G</p>	 <p>20MM GSLP-20-R</p>	

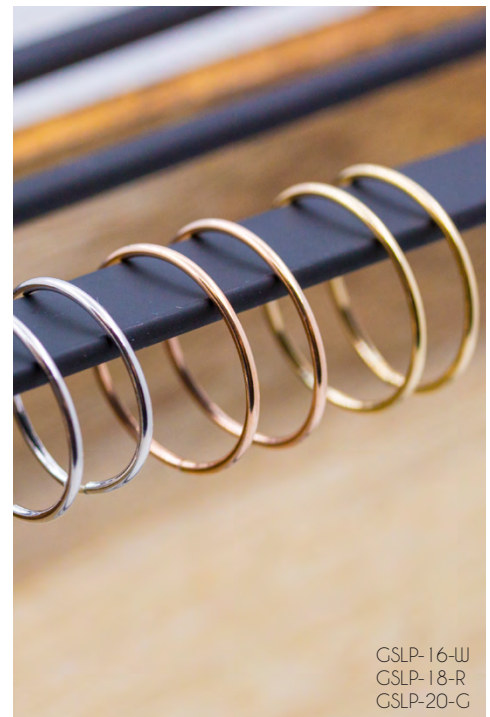

GSLP-16-W
GSLP-18-R
GSLP-20-G

10K GOLD BALL STUDS

 <p>3MM G-BE-3-10K</p>	 <p>4MM G-BE-4-10K</p>	 <p>5MM G-BE-5-10K</p>	 <p>6MM G-BE-6-10K</p>	 <p>7MM G-BE-7-10K</p>	 <p>8MM G-BE-8-10K</p>
---	---	---	---	---	---

10K BASKET SET CZ STUDS

 <p>2MM G-CZ-2-10K</p>	 <p>2.5MM G-CZ-2.5-10K</p>	 <p>3MM G-CZ-3-10K</p>	 <p>4MM G-CZ-4-10K</p>
 <p>5MM G-CZ-5-10K</p>	 <p>6MM G-CZ-6-10K</p>	 <p>7MM G-CZ-7-10K</p>	 <p>8MM G-CZ-8-10K</p>



GSLP-16-RC

10K GOLD LEVERBACKS

 <p>G-CZ-4-10K</p>	 <p>4MM G-CLB-4-10K</p>	 <p>5MM G-CLB-5-10K</p>	 <p>6MM G-CLB-6-10K</p>	 <p>8MM G-CLB-8-10K</p>
---	--	--	--	--

10K GOLD CZ PENDANTS

 <p>G-CLB-4-10K</p>	 <p>3MM G-P-3-10K</p>	 <p>4MM G-P-4-10K</p>	 <p>5MM G-P-5-10K</p>
--	--	--	--



14K GOLD & DIAMOND STUDS*



14K GOLD & DIAMOND HUGGIES*



14K GOLD & DIAMOND RINGS*



14K GOLD & DIAMOND NECKLACES & BRACELETS*



*ALL DIAMONDS ARE SI 1-2; GH QUALITY.

14K DIAMOND* NOSE RINGS	<p>1PT STRAIGHT</p> <p>WG-NS-S1</p>	<p>2.25PT STRAIGHT</p> <p>G-NS-S2</p>	<p>5PT STRAIGHT</p> <p>WG-NS-S5</p>	<p>1PT CURVY</p> <p>G-NS-C1</p>	<p>2.25PT CURVY</p> <p>WG-NS-C2</p>	<p>5PT CURVY</p> <p>G-NS-C5</p>
-------------------------	-------------------------------------	---------------------------------------	-------------------------------------	---------------------------------	-------------------------------------	---------------------------------

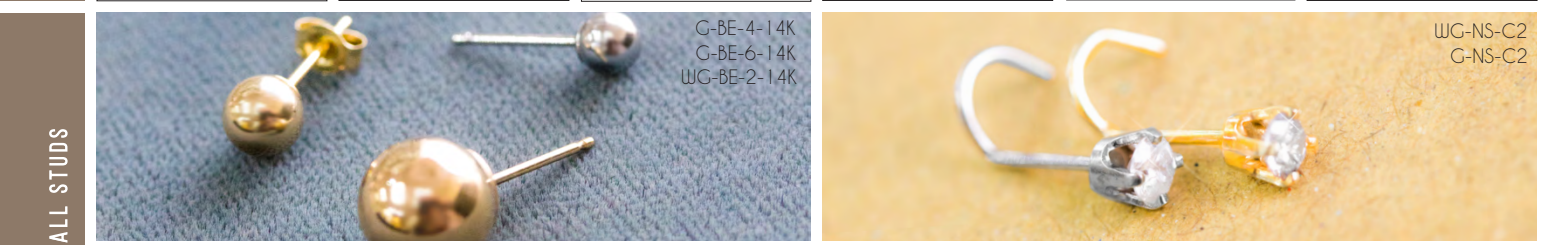

<p>2MM G-BE-2-14K</p>	<p>3MM WG-BE-3-14K</p>	<p>4MM G-BE-4-14K</p>	<p>5MM WG-BE-5-14K</p>	<p>6MM G-BE-6-14K</p>	<p>7MM WG-BE-7-14K</p>	<p>8MM WG-BE-8-14K</p>
---------------------------	----------------------------	---------------------------	----------------------------	---------------------------	----------------------------	----------------------------

14K GOLD BALL LEVERBACKS	<p>G-LB-4-14K G-LB-6-14K</p>	<p>3MM G-LB-3-14K</p>	<p>4MM G-LB-4-14K</p>	<p>5MM G-LB-5-14K</p>	<p>6MM G-LB-6-14K</p>	<p>7MM G-LB-7-14K</p>
--------------------------	----------------------------------	---------------------------	---------------------------	---------------------------	---------------------------	---------------------------

14K GOLD BASKET CZ STUDS	<p>2MM G-CZ-2-14K</p>	<p>2.5MM G-CZ-2.5-14K</p>	<p>3MM G-CZ-3-14K</p>	<p>4MM WG-CZ-4-14K</p>
	<p>5MM G-CZ-5-14K</p>	<p>6MM WG-CZ-6-14K</p>	<p>7MM G-CZ-7-14K</p>	<p>8MM WG-CZ-8-14K</p>

14K GOLD CZ LEVERBACKS	<p>3MM G-CLB-3-14K</p>	<p>4MM G-CLB-4-14K</p>	<p>8MM G-CLB-8-14K</p>
	<p>5MM G-CLB-5-14K</p>	<p>6MM G-CLB-6-14K</p>	<p>G-CLB-8-14K</p>

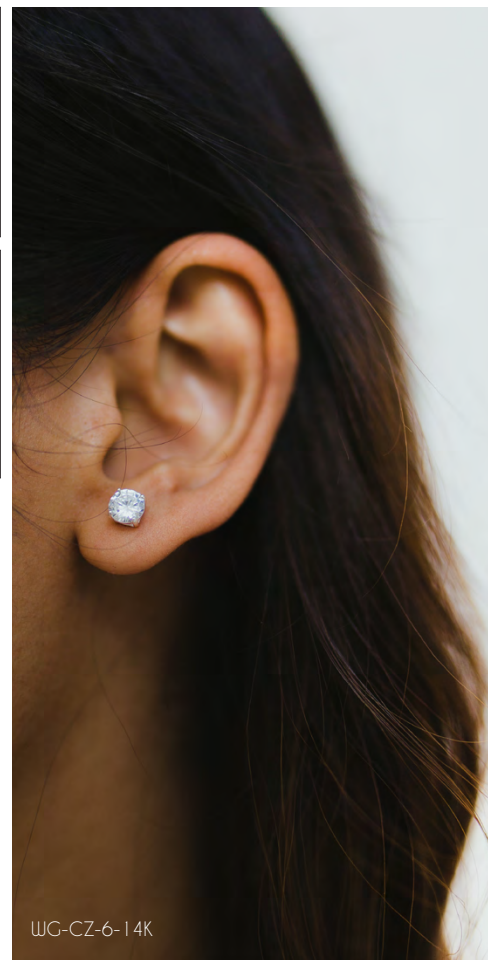

PERSONALIZED

STERLING SILVER EARRINGS P. 114

STERLING SILVER NECKLACES P. 114

STERLING SILVER RINGS P. 114

STERLING SILVER BRACELETS P. 115

STERLING SILVER ANKLETS P. 115

10K + 14K SOLID GOLD NECKLACES P. 116

10 + 14K SOLID GOLD BRACELETS P. 116

10K + 14K SOLID GOLD RINGS P. 116



STERLING SILVER EARRINGS



STERLING SILVER NECKLACES

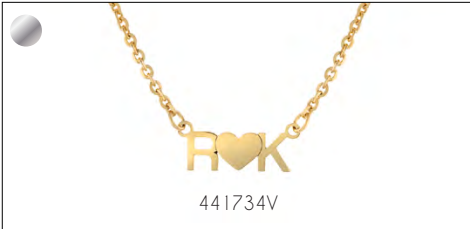

STERLING SILVER RINGS





LOOKING FOR KARAT GOLD PERSONALIZED JEWELLERY?

SOLID 10K & 14K GOLD NECKLACES



HOJ CARRIES A MODEST COLLECTION OF 10K + 14K GOLD PERSONALIZED JEWELLERY. THESE ITEMS ARE HAND CRAFTED IN TORONTO BY OUR LOCAL IN-HOUSE JEWELLER.



SOLID 10K & 14K GOLD BRACELETS



IF YOU ARE INTERESTED IN PLACING AN ORDER, PLEASE VISIT THE DEDICATED PAGE ON OUR WEBSITE FOR A FULL LIST OF OUR CURRENT SOLID GOLD DESIGNS.

SOLID 10K & 14K GOLD RINGS





ORDERING INFORMATION

TERMS + CONDITIONS P. 118

CREDIT APPLICATION P. 119

ORDER FORM P. 120

PRICE LIST P. 121 - 129

HOUSE OF JEWELLERY



EST. 1986

WITH OVER 3000 ITEMS IN STOCK, WE HAVE MADE IT EASY FOR OUR CUSTOMERS TO REVIEW ALL OUR PRODUCTS ON OUR WEBSITE WWW.HOUSEOFJEWELLERY.COM.

27 QUEEN STREET E. SUITE 1202
TORONTO, ONTARIO M5C 2M6
TEL: (416) 368-1682 | FAX: (416) 368-0007
TOLL FREE: 1-800-668-4422
E-MAIL: INFO@HOUSEOFJEWELLERY.COM
WWW.HOUSEOFJEWELLERY.COM

DEAR VALUED CUSTOMER,

WE ARE PROUD TO LAUNCH OUR 2022 STERLING SILVER & GOLD CATALOG III. THIS CATALOG HIGHLIGHTS A LARGE PORTION OF OUR PRODUCT LINE, HOWEVER, BE SURE TO VISIT OUR WEBSITE, TO SEE THE LATEST PRODUCT OFFERINGS. THANK YOU VERY MUCH FOR YOUR BUSINESS AND SUPPORT!

hoj team

TERMS AND CONDITIONS

TO SEE A COMPLETE LIST OF TERMS AND CONDITIONS, AS WELL AS OUR PRIVACY POLICY, PLEASE VISIT OUR WEBSITE: WWW.HOUSEOFJEWELLERY.COM.

MINIMUM ORDER: \$150.00 (EXCLUDING SHIPPING AND TAXES).

ORDERING: PHONE: (416) 368 - 1682 | TOLL FREE: 1 (800) 668 - 4422 | FAX: (416) 368 - 0007
EMAIL: INFO@HOUSEOFJEWELLERY.COM | WEBSITE: WWW.HOUSEOFJEWELLERY.COM

ORDERS SUBMITTED ONLINE: E-MAIL CONFIRMATIONS ARE SENT UPON RECEIVING AN ORDER. AN ELECTRONIC RECEIPT/INVOICE WILL BE SENT TO YOU ONCE THE ORDER IS READY TO BE SHIPPED. HARD COPY RECEIPTS/INVOICES WILL ACCOMPANY YOUR PACKAGE. E-MAIL SHIPPING NOTICES AND TRACKING NUMBERS ARE SENT ONCE THE ORDER HAS LEFT OUR OFFICE.

PAYMENT TERMS: THE FIRST ORDER MUST BE PRE-PAID BY CREDIT CARD (VISA OR MASTERCARD) OR INTERACT E-TRANSFER UNTIL CREDIT IS ESTABLISHED. NET 30-DAY TERMS WILL BE GIVEN TO COMPANIES WITH COMPLETED AND APPROVED CREDIT APPLICATIONS ON FILE. A CREDIT APPLICATION CAN BE FOUND ON OUR WEBSITE OR ON **PAGE 119** OF THE CATALOG.

DELIVERY: ORDERS ARE USUALLY SHIPPED WITHIN 24 - 48 HOURS OF RECEIPT. WE PROMISE TO PREPARE AND SHIP YOUR ORDER AS QUICKLY AS POSSIBLE. CHANGES TO ORDERS MAY DELAY SHIPPING. ALL ORDERS ARE SHIPPED WITH YOUR PREFERRED COURIER METHOD (FEDEX, UPS, CANADA POST, CANPAR, OR PUROLATOR). A HANDLING FEE WILL BE CHARGED ON ALL ORDERS WHEN THE USE OF YOUR SHIPPING ACCOUNT NUMBER IS REQUESTED. DROPSHIPING MAY BE AVAILABLE UPON REQUEST. BACKORDERED ITEMS WILL AUTOMATICALLY SHIP UNLESS OTHERWISE NOTIFIED. WE DO OFFER PICKUP AND/OR CASH AND CARRY.

CLAIMS: ALL CLAIMS MUST BE MADE TO HOUSE OF JEWELLERY IMMEDIATELY UPON RECEIPT OF GOODS. CLAIMS MADE AFTER **7 DAYS** AFTER RECEIVING MERCHANDISE WILL NOT BE HONOURED.

RETURNS: RETURNS ARE NOT ACCEPTED WITHOUT PRIOR APPROVAL. PLEASE CONTACT US FOR A RA#. UNAUTHORIZED RETURNS WILL NOT BE HONOURED. RETURNS MADE AFTER 7 DAYS OF RECEIPT WILL NOT BE HONOURED UNLESS THE CAUSE FOR THE RETURN IS DAMAGE OR INCORRECT SHIPMENT. RETURNS ARE SUBJECT TO A **15% RESTOCKING FEE**.

PRICING: ALL PRICES LISTED ARE IN CANADIAN CURRENCY (CAD) FOB AND ARE SUBJECT TO CHANGE WITHOUT PRIOR NOTICE. PRICES ARE BASED UPON SILVER @ US\$25/OZ AND GOLD @ US\$1800/OZ. ALL PRICES ARE WHOLESAL. TAXES ARE EXTRA WHERE APPLICABLE.



EST. 1986

CREDIT APPLICATION

CREDIT APPLICATION WILL NOT BE PROCESSED UNLESS THIS FORM IS COMPLETED IN FULL, SIGNED AND DATED.

BILL TO _____

LEGAL BUS. NAME _____

ADDRESS _____

CITY _____ PROVINCE _____

POSTAL CODE _____

FAX _____ PHONE _____

EMAIL _____

SHIP TO SAME AS BILL TO

LEGAL BUS. NAME _____

ADDRESS _____

CITY _____ PROVINCE _____

POSTAL CODE _____

FAX _____ PHONE _____

EMAIL _____

CHECK ALL THAT APPLY

WHOLESALER RETAILER CORPORATION SOLE PROPRIETOR PARTNERSHIP OTHER

IF RETAILER PLEASE FILL IN

TYPE OF STORE _____ NO. OF STORES _____ DATE BUSINESS STARTED _____

BANK _____ CITY _____ PROVINCE _____

POSTAL CODE _____ PROVINCIAL TAX NO. _____

CONTACT NAME _____ PHONE NUMBER _____ EMAIL _____

ACTIVE TRADE REFERENCES ONLY: CURRENT CREDIT ACCOUNTS WITH JEWELLERY SUPPLIERS ONLY.

1. COMPANY NAME _____ CONTACT NAME _____ PHONE _____ EXT _____

ADDRESS _____ CITY _____ PROVINCE _____

POSTAL CODE _____ EMAIL _____

2. COMPANY NAME _____ CONTACT NAME _____ PHONE _____ EXT _____

ADDRESS _____ CITY _____ PROVINCE _____

POSTAL CODE _____ EMAIL _____

3. COMPANY NAME _____ CONTACT NAME _____ PHONE _____ EXT _____

ADDRESS _____ CITY _____ PROVINCE _____

POSTAL CODE _____ EMAIL _____

4. COMPANY NAME _____ CONTACT NAME _____ PHONE _____ EXT _____

ADDRESS _____ CITY _____ PROVINCE _____

POSTAL CODE _____ EMAIL _____

ACCOUNTS PAST DUE 30 DAYS OR MORE WILL BE CHARGED INTEREST AT THE RATE OF 2% OF THE BALANCE OWED PER MONTH FOR A TOTAL OF 24% PER ANNUM OR THE HIGHEST RATE ALLOWED BY LAW. IN THE EVENT ANY AMOUNT MUST BE REFERENCED TO AN ATTORNEY OR COLLECTION AGENCY TO ENFORCE COLLECTION OF ANY INDEBTEDNESS OWED BY THE UNDERSIGNED OF HOUSE OF JEWELLERY. THE UNDERSIGNED AGREES TO PAY ALL REASONABLE COST THEREOF INCLUDING COLLECTION FEES AND REASONABLE ATTORNEY FEES.

NAME _____ SIGNATURE _____ TITLE _____ DATE _____

27 QUEEN STREET E. SUITE 1202
 TORONTO, ONTARIO M5C 2M6
 TEL: (416) 368-1682 | FAX: (416) 368-0007

TOLL FREE: 1-800-668-4422
 E-MAIL: INFO@HOUSEOFJEWELLERY.COM
 WWW.HOUSEOFJEWELLERY.COM

HOUSE OF JEWELLERY



EST. 1986

ORDER FORM

E-MAIL ORDERS TO INFO@HOUSEOFJEWELLERY.COM

DATE _____

AUTOMATICALLY BACKORDER?

P.O.# _____

CALL IF MERCHANDISE OUT-OF-STOCK?

BILL TO:

NAME _____

ADDRESS _____

CITY _____ PROVINCE _____ POSTAL CODE _____

PHONE _____ CONTACT NAME _____

SHIP TO:

NAME _____

ADDRESS _____

CITY _____ PROVINCE _____ POSTAL CODE _____

STORE PHONE _____

SHIP VIA: NEXT DAY 2-DAY GROUND PICK-UP

METHOD OF PAYMENT:

VISA

MASTERCARD

E-TRANSFER

ON ACCOUNT

NAME AS IT APPEARS ON CARD: _____

CARD# _____ EXP. DATE _____ CODE _____

LINE	PAGE#	PRODUCT ID	QUANTITY	MATERIAL	LENGTH	SIZE	COLOUR
1				<input type="checkbox"/> STERLING SILVER <input type="checkbox"/> 10K <input type="checkbox"/> 14K			
2				<input type="checkbox"/> STERLING SILVER <input type="checkbox"/> 10K <input type="checkbox"/> 14K			
3				<input type="checkbox"/> STERLING SILVER <input type="checkbox"/> 10K <input type="checkbox"/> 14K			
4				<input type="checkbox"/> STERLING SILVER <input type="checkbox"/> 10K <input type="checkbox"/> 14K			
5				<input type="checkbox"/> STERLING SILVER <input type="checkbox"/> 10K <input type="checkbox"/> 14K			
6				<input type="checkbox"/> STERLING SILVER <input type="checkbox"/> 10K <input type="checkbox"/> 14K			
7				<input type="checkbox"/> STERLING SILVER <input type="checkbox"/> 10K <input type="checkbox"/> 14K			
8				<input type="checkbox"/> STERLING SILVER <input type="checkbox"/> 10K <input type="checkbox"/> 14K			
9				<input type="checkbox"/> STERLING SILVER <input type="checkbox"/> 10K <input type="checkbox"/> 14K			
10				<input type="checkbox"/> STERLING SILVER <input type="checkbox"/> 10K <input type="checkbox"/> 14K			
11				<input type="checkbox"/> STERLING SILVER <input type="checkbox"/> 10K <input type="checkbox"/> 14K			
12				<input type="checkbox"/> STERLING SILVER <input type="checkbox"/> 10K <input type="checkbox"/> 14K			
13				<input type="checkbox"/> STERLING SILVER <input type="checkbox"/> 10K <input type="checkbox"/> 14K			
14				<input type="checkbox"/> STERLING SILVER <input type="checkbox"/> 10K <input type="checkbox"/> 14K			





HOUSE OF JEWELLERY SIZE GUIDES

RINGS

HOJ RECOMMENDS SIZES 6 - 8 FOR WOMEN AND 10 - 12 FOR MEN. THE FOLLOWING DIAGRAM ILLUSTRATES THE APPROXIMATE MM OF THE MOST POPULAR RING SIZES:

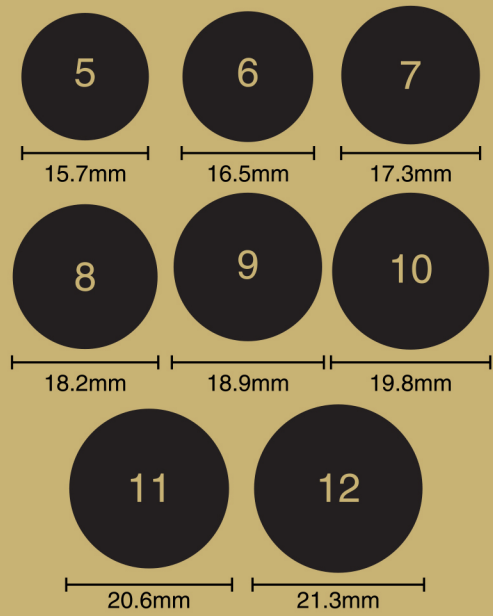

CHAINS

CHAIN LENGTHS ARE AVAILABLE FROM 14 INCHES TO 98 INCHES IN SELECT STYLES. TYPICALLY, WOMEN STICK TO 14" - 24" WHILE MEN USUALLY WEAR 24" - 28".

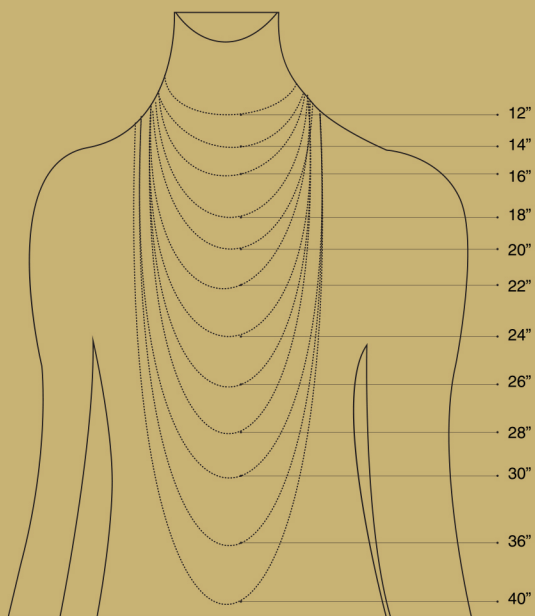

27 QUEEN STREET E, SUITE 1202
TORONTO, ONTARIO M5C 2M6
TEL: (416) 368-1682
FAX: (416) 368-0007
TOLL FREE: 1-800-668-4422
INFO@HOUSEOFJEWELLERY.COM
WWW.HOUSEOFJEWELLERY.COM

